

2250

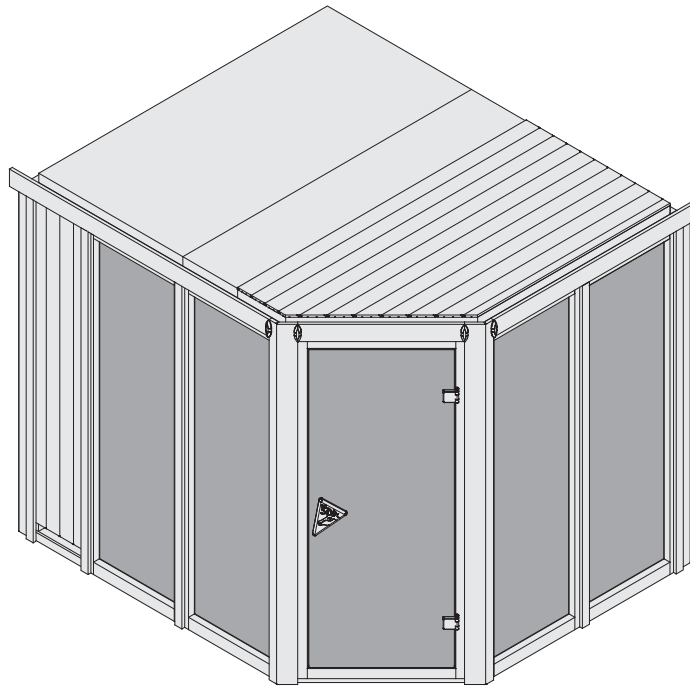

Das komplette
Farbangebot
finden Sie auf:

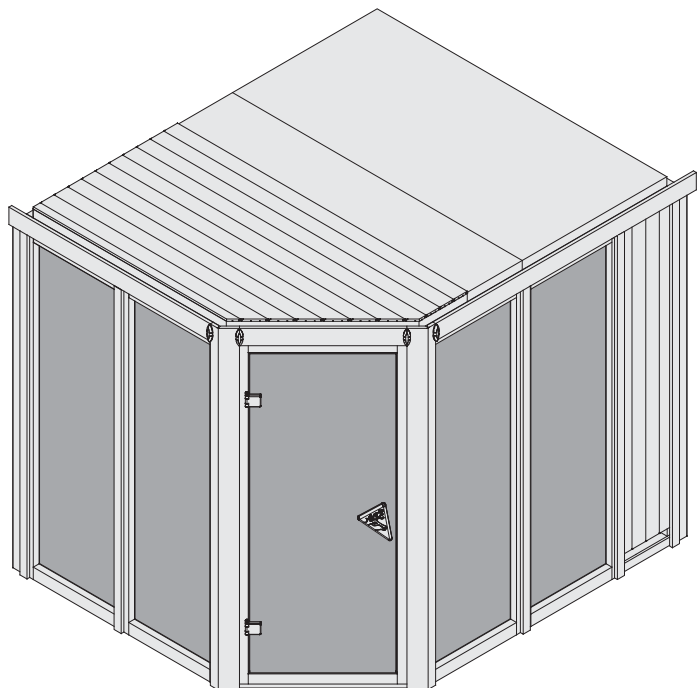

www.KARIBU-FARBESHOP.de

-  **Aufbauanleitung**
-  **Building Instructions**
-  **notice de montage**
-  **montagehandleiding**
-  **Montagevejledning**
-  **Instrucciones de construcción**
-  **Istruzioni per il montaggio**
-  **Montážní návod**
-  **Navodila za sestavljanje**

Technische Daten

In der Auftragsbestätigung bzw. Lieferschein ist der gekaufte Ofentyp bzw. das erworbene Steuergerät zu finden. Bitte entnehmen Sie die technischen Daten Ihrer Geräte der folgenden Auflistung

	Netzspannung	Wattage
Ofen		
9kW Bio	400V ~ 3N	9kW
9kW Finnisch	400V ~ 3N	9kW
9kW integr. Steuerung	400V ~ 3N	9kW
4,5kW Bio	400V ~ 3N	4,5kW
4,5kW Finnisch	400V ~ 3N	4,5kW
4,5kW integr. Steuerung	400V ~ 3N	4,5kW
3,6kW Bio	230V ~ 1N	3,6kW
3,6kW Finnisch	230V ~ 1N	3,6kW
3,6kW integr. Steuerung	230V ~ 1N	3,6kW
Steuergerät		
externe Easy Bio	400V ~ 3N	max. 10,8kW
externe Plug&Play Bio	240V ~ 3N	max. 10,8kW
externe Finnisch	400V ~ 3N	max. 10,8kW
externe Plug&Play Finnisch	240V ~ 3N	max. 10,8kW
Multisteuergerät	400V ~ 3N	max. 10,5kW
externe Classic Bio	400V ~ 3N	max. 9kW
externe Classic Finnisch	400V ~ 3N	max. 9kW
externe Premium Bio	400V ~ 3N	max. 12kW
externe Premium Finnisch	400V ~ 3N	max. 9kW

Technical data

The type of oven or control unit purchased can be found in the order confirmation or delivery note. Please refer to the following list for the technical data of your units

	Mains voltage	Wattage
Oven		
9kW Bio	400V ~ 3N	9kW
9kW Finnisch	400V ~ 3N	9kW
9kW integrated Control unit	400V ~ 3N	9kW
4,5kW Bio	400V ~ 3N	4,5kW
4,5kW Finnisch	400V ~ 3N	4,5kW
4,5kW integrated Control unit	400V ~ 3N	4,5kW
3,6kW Bio	230V ~ 1N	3,6kW
3,6kW Finnisch	230V ~ 1N	3,6kW
3,6kW integrated Control unit	230V ~ 1N	3,6kW
Control unit		
External Easy Bio	400V ~ 3N	max. 10,8kW
External Plug&Play Bio	240V ~ 3N	max. 10,8kW
External Finnisch	400V ~ 3N	max. 10,8kW
External Plug&Play Finnisch	240V ~ 3N	max. 10,8kW
Multi-controller	400V ~ 3N	max. 10,5kW
External Classic Bio	400V ~ 3N	max. 9kW
External Classic Finnisch	400V ~ 3N	max. 9kW
External Premium Bio	400V ~ 3N	max. 12kW
External Premium Finnisch	400V ~ 3N	max. 9kW

Données techniques

Dans la confirmation de commande ou le bon de livraison, vous trouverez le type de four ou l'appareil de commande que vous avez acheté. Veuillez consulter les données techniques de vos appareils dans la liste suivante

	Tension du réseau	Wattage
Four		
9kW Bio	400V ~ 3N	9kW
9kW Finnisch	400V ~ 3N	9kW
9kW intégré Unité de contrôle	400V ~ 3N	9kW
4,5kW Bio	400V ~ 3N	4,5kW
4,5kW Finnisch	400V ~ 3N	4,5kW
4,5kW intégré Unité de contrôle	400V ~ 3N	4,5kW
3,6kW Bio	230V ~ 1N	3,6kW
3,6kW Finnisch	230V ~ 1N	3,6kW
3,6kW intégré Unité de contrôle	230V ~ 1N	3,6kW
Unité de contrôle		
Externe Easy Bio	400V ~ 3N	max. 10,8kW
Externe Plug&Play Bio	240V ~ 3N	max. 10,8kW
Externe Finnisch	400V ~ 3N	max. 10,8kW
Externe Plug&Play Finnisch	240V ~ 3N	max. 10,8kW
Appareil de commande multiple	400V ~ 3N	max. 10,5kW
Externe Classic Bio	400V ~ 3N	max. 9kW
Externe Classic Finnisch	400V ~ 3N	max. 9kW
Externe Premium Bio	400V ~ 3N	max. 12kW
Externe Premium Finnisch	400V ~ 3N	max. 9kW

Technische gegevens

Het type oven of besturingseenheid dat u hebt gekocht, vindt u in de orderbevestiging of leveringsbon. Raadpleeg de volgende lijst voor de technische gegevens van uw apparaten

	Netspanning	Wattage
Oven		
9kW Bio	400V ~ 3N	9kW
9kW Finnisch	400V ~ 3N	9kW
9kW geïntegreerd Besturingseenheid	400V ~ 3N	9kW
4,5kW Bio	400V ~ 3N	4,5kW
4,5kW Finnisch	400V ~ 3N	4,5kW
4,5kW geïntegreerd Besturingseenheid	400V ~ 3N	4,5kW
3,6kW Bio	230V ~ 1N	3,6kW
3,6kW Finnisch	230V ~ 1N	3,6kW
3,6kW geïntegreerd Besturingseenheid	230V ~ 1N	3,6kW
Besturingseenheid		
Extern Easy Bio	400V ~ 3N	max. 10,8kW
Extern Plug&Play Bio	240V ~ 3N	max. 10,8kW
Extern Finnisch	400V ~ 3N	max. 10,8kW
Extern Plug&Play Finnisch	240V ~ 3N	max. 10,8kW
Multi-controller	400V ~ 3N	max. 10,5kW
Extern Classic Bio	400V ~ 3N	max. 9kW
Extern Classic Finnisch	400V ~ 3N	max. 9kW
Extern Premium Bio	400V ~ 3N	max. 12kW
Extern Premium Finnisch	400V ~ 3N	max. 9kW

Tekniske data

Hvilken type ovn eller styreenhed, du har købt, fremgår af ordrebekræftelsen eller følgesedlen. Se venligst følgende liste for de tekniske data for dine enheder

	Netspænding	Wattforbrug
Ovn		
9kW Bio	400V ~ 3N	9kW
9kW Finnisch	400V ~ 3N	9kW
9kW integreret Kontrolenhed	400V ~ 3N	9kW
4,5kW Bio	400V ~ 3N	4,5kW
4,5kW Finnisch	400V ~ 3N	4,5kW
4,5kW integreret Kontrolenhed	400V ~ 3N	4,5kW
3,6kW Bio	230V ~ 1N	3,6kW
3,6kW Finnisch	230V ~ 1N	3,6kW
3,6kW integreret Kontrolenhed	230V ~ 1N	3,6kW
Kontrolenhed		
Ekstern Easy Bio	400V ~ 3N	max. 10,8kW
Ekstern Plug&Play Bio	240V ~ 3N	max. 10,8kW
Ekstern Finnisch	400V ~ 3N	max. 10,8kW
Ekstern Plug&Play Finnisch	240V ~ 3N	max. 10,8kW
Multi-controller	400V ~ 3N	max. 10,5kW
Ekstern Classic Bio	400V ~ 3N	max. 9kW
Ekstern Classic Finnisch	400V ~ 3N	max. 9kW
Ekstern Premium Bio	400V ~ 3N	max. 12kW
Ekstern Premium Finnisch	400V ~ 3N	max. 9kW

Datos técnicos

El tipo de horno o unidad de control adquirida figura en la confirmación del pedido o en el albarán de entrega. Consulte en la siguiente lista los datos técnicos de sus unidades.

	Tensión de red	Vatios
Horno		
9kW Bio	400V ~ 3N	9kW
9kW Finnisch	400V ~ 3N	9kW
9kW integrado Unidad de control	400V ~ 3N	9kW
4,5kW Bio	400V ~ 3N	4,5kW
4,5kW Finnisch	400V ~ 3N	4,5kW
4,5kW integrado Unidad de control	400V ~ 3N	4,5kW
3,6kW Bio	230V ~ 1N	3,6kW
3,6kW Finnisch	230V ~ 1N	3,6kW
3,6kW integrado Unidad de control	230V ~ 1N	3,6kW
Unidad de control		
Exterior Easy Bio	400V ~ 3N	max. 10,8kW
Exterior Plug&Play Bio	240V ~ 3N	max. 10,8kW
Exterior Finnisch	400V ~ 3N	max. 10,8kW
Exterior Plug&Play Finnisch	240V ~ 3N	max. 10,8kW
Mando múltiple	400V ~ 3N	max. 10,5kW
Exterior Classic Bio	400V ~ 3N	max. 9kW
Exterior Classic Finnisch	400V ~ 3N	max. 9kW
Exterior Premium Bio	400V ~ 3N	max. 12kW
Exterior Premium Finnisch	400V ~ 3N	max. 9kW

 **Dati tecnici**

Il tipo di forno o di unità di controllo acquistato è riportato nella conferma d'ordine o nella bolla di consegna. Per i dati tecnici delle unità, consultare il seguente elenco

	Tensione di rete	Potenza
Forno		
9kW Bio	400V ~ 3N	9kW
9kW Finnisch	400V ~ 3N	9kW
9kW integrato Unità di controllo	400V ~ 3N	9kW
4,5kW Bio	400V ~ 3N	4,5kW
4,5kW Finnisch	400V ~ 3N	4,5kW
4,5kW integrato Unità di controllo	400V ~ 3N	4,5kW
3,6kW Bio	230V ~ 1N	3,6kW
3,6kW Finnisch	230V ~ 1N	3,6kW
3,6kW integrato Unità di controllo	230V ~ 1N	3,6kW
Unità di controllo		
Esterno Easy Bio	400V ~ 3N	max. 10,8kW
Esterno Plug&Play Bio	240V ~ 3N	max. 10,8kW
Esterno Finnisch	400V ~ 3N	max. 10,8kW
Esterno Plug&Play Finnisch	240V ~ 3N	max. 10,8kW
Controllore multiplo	400V ~ 3N	max. 10,5kW
Esterno Classic Bio	400V ~ 3N	max. 9kW
Esterno Classic Finnisch	400V ~ 3N	max. 9kW
Esterno Premium Bio	400V ~ 3N	max. 12kW
Esterno Premium Finnisch	400V ~ 3N	max. 9kW

 **Technické údaje**

Typ zakoupené trouby nebo řídicí jednotky naleznete v potvrzení objednávky nebo v dodacím listu. Technické údaje vašich jednotek naleznete v následujícím seznamu

	Síťové napětí	Příkon
Trouba		
9kW Bio	400V ~ 3N	9kW
9kW Finnisch	400V ~ 3N	9kW
9kW integrovaný Řídicí jednotka	400V ~ 3N	9kW
4,5kW Bio	400V ~ 3N	4,5kW
4,5kW Finnisch	400V ~ 3N	4,5kW
4,5kW integrovaný Řídicí jednotka	400V ~ 3N	4,5kW
3,6kW Bio	230V ~ 1N	3,6kW
3,6kW Finnisch	230V ~ 1N	3,6kW
3,6kW integrovaný Řídicí jednotka	230V ~ 1N	3,6kW
Řídicí jednotka		
Externí Easy Bio	400V ~ 3N	max. 10,8kW
Externí Plug&Play Bio	240V ~ 3N	max. 10,8kW
Externí Finnisch	400V ~ 3N	max. 10,8kW
Externí Plug&Play Finnisch	240V ~ 3N	max. 10,8kW
Multi-controller	400V ~ 3N	max. 10,5kW
Externí Classic Bio	400V ~ 3N	max. 9kW
Externí Classic Finnisch	400V ~ 3N	max. 9kW
Externí Premium Bio	400V ~ 3N	max. 12kW
Externí Premium Finnisch	400V ~ 3N	max. 9kW

 **Tehnični podatki**

Vrsta kupljene pečice ali krmilne enote je navedena v potrditvi naročila ali dobavnici. Tehnične podatke vaših enot najdete na naslednjem seznamu

	Omrežna napetost	Moč
Pečica		
9kW Bio	400V ~ 3N	9kW
9kW Finnisch	400V ~ 3N	9kW
9kW integriran Nadzorna enota	400V ~ 3N	9kW
4,5kW Bio	400V ~ 3N	4,5kW
4,5kW Finnisch	400V ~ 3N	4,5kW
4,5kW integriran Nadzorna enota	400V ~ 3N	4,5kW
3,6kW Bio	230V ~ 1N	3,6kW
3,6kW Finnisch	230V ~ 1N	3,6kW
3,6kW integriran Nadzorna enota	230V ~ 1N	3,6kW
Nadzorna enota		
Zunanja stran Easy Bio	400V ~ 3N	max. 10,8kW
Zunanja stran Plug&Play Bio	240V ~ 3N	max. 10,8kW
Zunanja stran Finnisch	400V ~ 3N	max. 10,8kW
Zunanja stran Plug&Play Finnisch	240V ~ 3N	max. 10,8kW
Več krmilnikov	400V ~ 3N	max. 10,5kW
Zunanja stran Classic Bio	400V ~ 3N	max. 9kW
Zunanja stran Classic Finnisch	400V ~ 3N	max. 9kW
Zunanja stran Premium Bio	400V ~ 3N	max. 12kW
Zunanja stran Premium Finnisch	400V ~ 3N	max. 9kW

Bitte bewahren Sie die Anleitung und den Garantieschein zur Seriennummer auf.

Vernichten Sie diese erst nach Ablauf der Garantiezeit.

Eventuelle Beanstandungen können mithilfe der Stückliste einfacher zugeordnet werden.

Beigelegte Dokumente

- Informationsheft
- Garantieschein zur Seriennummer
- Typenschild inkl. Warnhinweise (Sauna)
- ggf. Zubehör-Anleitungen in externen Paketen

- *  Nicht im Lieferumfang enthalten
 Not included
 Non comprises dans la livraison
 Niet bijgeleverd

-  No forman parte del suministro
 Non incluso
 V ceně není zahrnuto
 Ikke inkluderet
 Ni včlučeno v obseg dobave

- 1  Länge muss ermittelt und zugesagt werden
 Length must be determined and sawn
 La longueur doit être déterminée et sciée
 De lengte moet worden bepaald en worden gezaagd

-  La longitud debe ser determinada y aserrada
 La lunghezza deve essere determinata e segata
 Délka musí být určena a rozřezána
 Længden skal bestemmes og saves
 Določiti je treba dolžino in jo odrezati po velikosti.

- 2  Nicht gebraucht
 Not needed
 Pas nécessaire
 Niet nodig

-  No es necesario
 Non necessario
 Není nutná
 Ikke nødvendigt
 Ne uporabljaja se

- 3  Mit Zubehör
 With accessories
 Avec accessoires
 Met toebehoren

-  Con accesorios
 Con accessori
 S příslušenstvím
 Med tilbehør
 Z dodatki

- 4  Fixiert vorübergehend
 Fixed temporarily
 Temporairement fixe
 Tijdelijk vast

-  Temporalmente fijo
 Temporaneamente fisso
 Dočasně pevný
 Midlertidigt rettet
 Začasno popravi

- 5  Bestand vom Haus
 Inventory of the house
 Inventaire de la maison
 Inventaris von het huis

-  Inventario de la casa
 Inventario della casa
 Inventář domu
 Inventar af huset
 Inventarizacija hiše

 Vergleichen Sie zuerst die Material-liste mit Ihrem Paketinhalt! Bitte haben Sie Verständnis, dass Beanstandungen nur im nicht aufgebauten Zustand bearbeitet werden können!

 First compare the list of materials with your package contents! Please understand that complaints can be processed in the non-built status only!

 Commencez par comparer la liste du matériel avec le contenu de votre paquet! Sachez que nous traitons uniquement les réclamations concernant le matériel à l'état non monté!

 Vergelijk eerst de lijst van materialen met de inhoud van uw pakket! Reclamaties kunnen alleen in behandeling worden genomen zolang de onderdelen nog niet zijn gemonteerd!

 Start med at kontrollere materialelisten med indholdet af den leverede pakke! Vi gør venligst opmærksom på at reklamationer kun kan behandles for materialer som ikke er blevet bearbejdet!

 En primer lugar, compare la lista de material con el contenido del paquete. Rogamos entienda que las reclamaciones sólo pueden ser tramitadas antes de montar el objeto!

 Confrontate questa distinta materiali prima con il contenuto del pacchetto! Vi preghiamo di comprendere che eventuali reclami possono essere accolti solo prima del montaggio!

 Nejprve přezkontrolujte obsah balení podle materiálového listu! Mějte pochopení pro to, že případnou reklamaci se můžeme zabývat pouze tehdy, když díly nebudou smontované! Za pomoci tohoto seznamu můžete jednotlivé díly přiřadit k montážnímu návodu.

 Najprej primerajte zoznam materialov z vsebino vašega paketa! Upoštevajte, da lahko pritožbe obravnavamo le v nesestavljenem stanju!

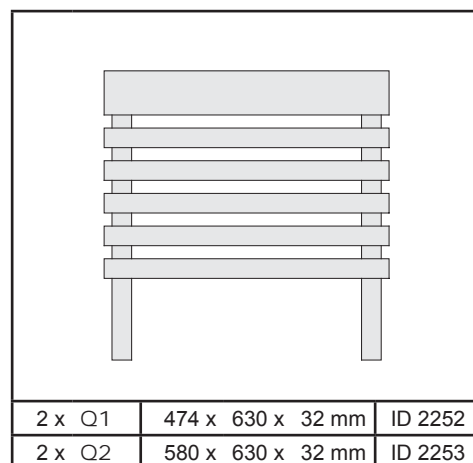
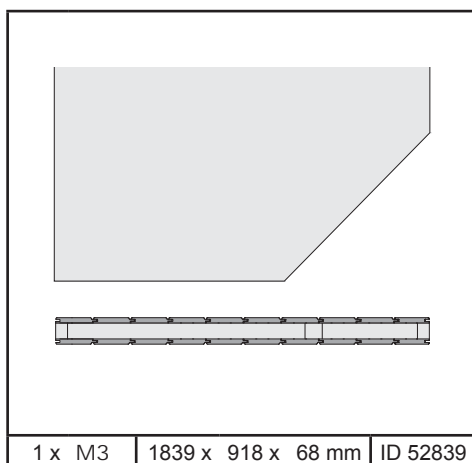
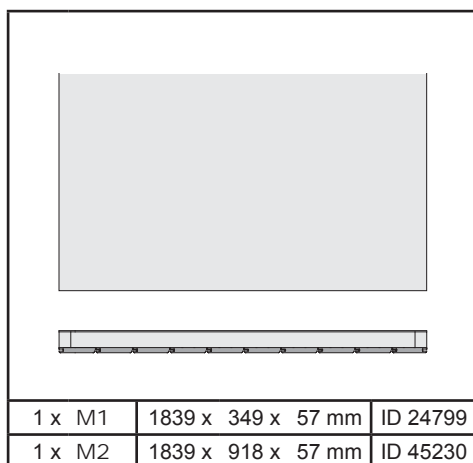
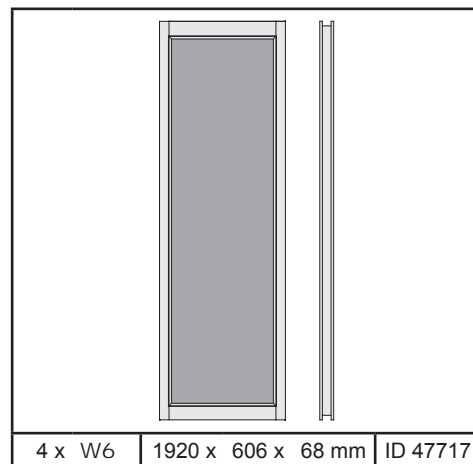
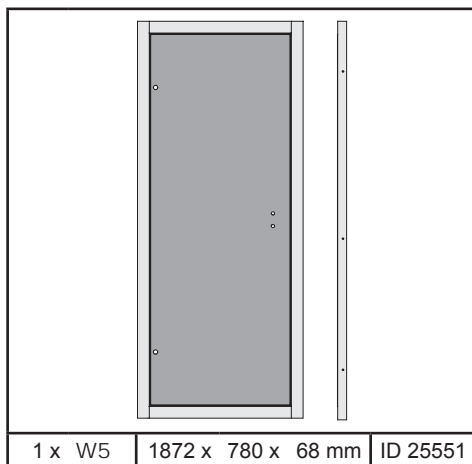
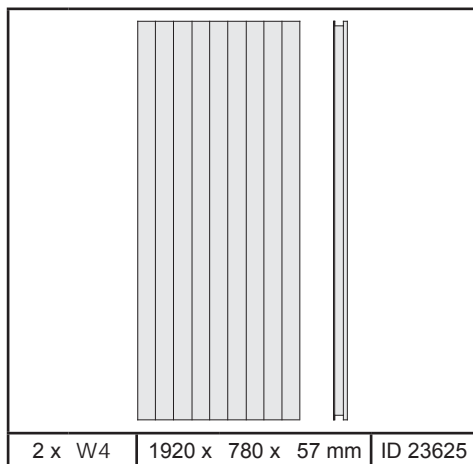
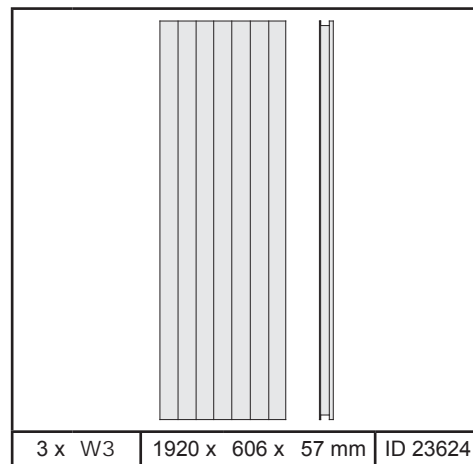
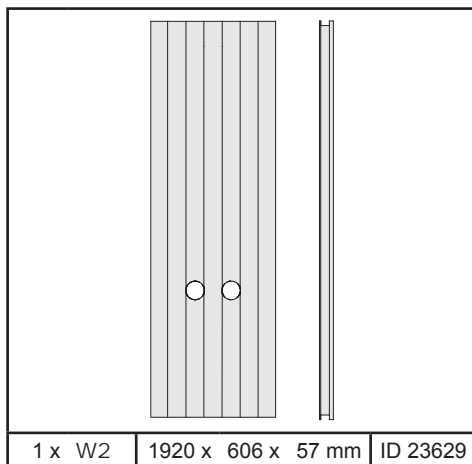
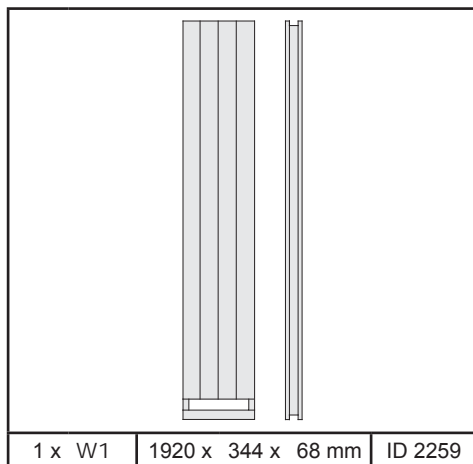
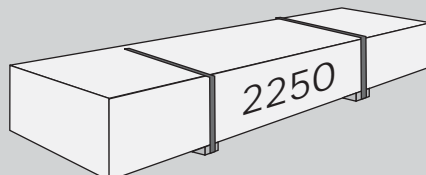

9 x B1	1920 x	19 x	3 mm ID 20799
1 x B2	1244 x	90 x	16 mm ID 2255
1 x B3	1606 x	90 x	16 mm ID 2254
1 x B4	1625 x	90 x	16 mm ID 2256
6 x B5	800 x	45 x	18 mm ID 24796
5 x B6	1884 x	45 x	18 mm ID 48037
3 x B7	314 x	95 x	18 mm ID 81102
1 x B8	765 x	95 x	18 mm ID 26357
1 x B9	1278 x	95 x	18 mm ID 25575
1 x B10	1656 x	95 x	18 mm ID 79752
1 x B11	300 x	120 x	18 mm ID 22467
1 x B12	1410 x	42 x	28 mm ID 24101
1 x B13	1812 x	42 x	28 mm ID 24123
2 x B14	1923 x	42 x	28 mm ID 26362
1 x B15	2105 x	42 x	28 mm ID 24125
2 x B16	2187 x	42 x	28 mm ID 24534
3 x B17	1874 x	52 x	52 mm ID 26165

1 x C1	1209 x	42 x	28 mm ID 24124
2 x C2	1288 x	42 x	28 mm ID 26364
1 x C3	1530 x	42 x	28 mm ID 24126
2 x C4	1592 x	42 x	28 mm ID 26363

1 x C5	852 x	42 x	28 mm ID 24111
2 x C6	896 x	42 x	28 mm ID 24110

2 x E1	1920 x	97 x	12 mm ID 22863

2 x G1	1884 x	45 x	17 mm ID 48538
2 x G2	1980 x	45 x	17 mm ID 48539
2 x G3	1980 x	95 x	17 mm ID 48540

2 x K1	1874 x	76 x	38 mm ID 43464

1 x L1	1260 x	550 x	90 mm ID 52062
1 x L2	1625 x	550 x	90 mm ID 26169
1 x L3	2156 x	550 x	90 mm ID 21768

3 x L4	528 x	174 x	32 mm ID 6917
1 x L5	1227 x	174 x	32 mm ID 2258
4 x L6	1606 x	174 x	32 mm ID 2257

2 x L7	595 x	510 x	95 mm ID 62992
2 x L8	895 x	512 x	95 mm ID 16811

1 x L9	400 x	300 x	80 mm ID 20708

1 x X4			ID 26496

100 x	4 x 30 mm	ID 3686
100 x	4 x 50 mm	ID 3688
40 x	4 x 70 mm	ID 3689
40 x	4,5 x 80 mm	ID 9204
10 x	6 x 60 mm	ID 14014

60 x	4,5 x 40 mm	ID 26285

6 x	6 x 80 mm	ID 14266

60 x	4,5 x 30 mm	ID 26116
6 x	12 x 18 mm	ID 46403

3 x	8 x 70 mm	ID 42172

4 x		ID 26272

2 x	5 x 5 x 3,5 mm	ID 21292

1 x	10 mm	ID 14025

1 x		ID 26114

-  Übersicht
-  Overview
-  enquête

-  overzicht
-  undersøgelse
-  estudio

-  sondaggio
-  přehled
-  Pregled

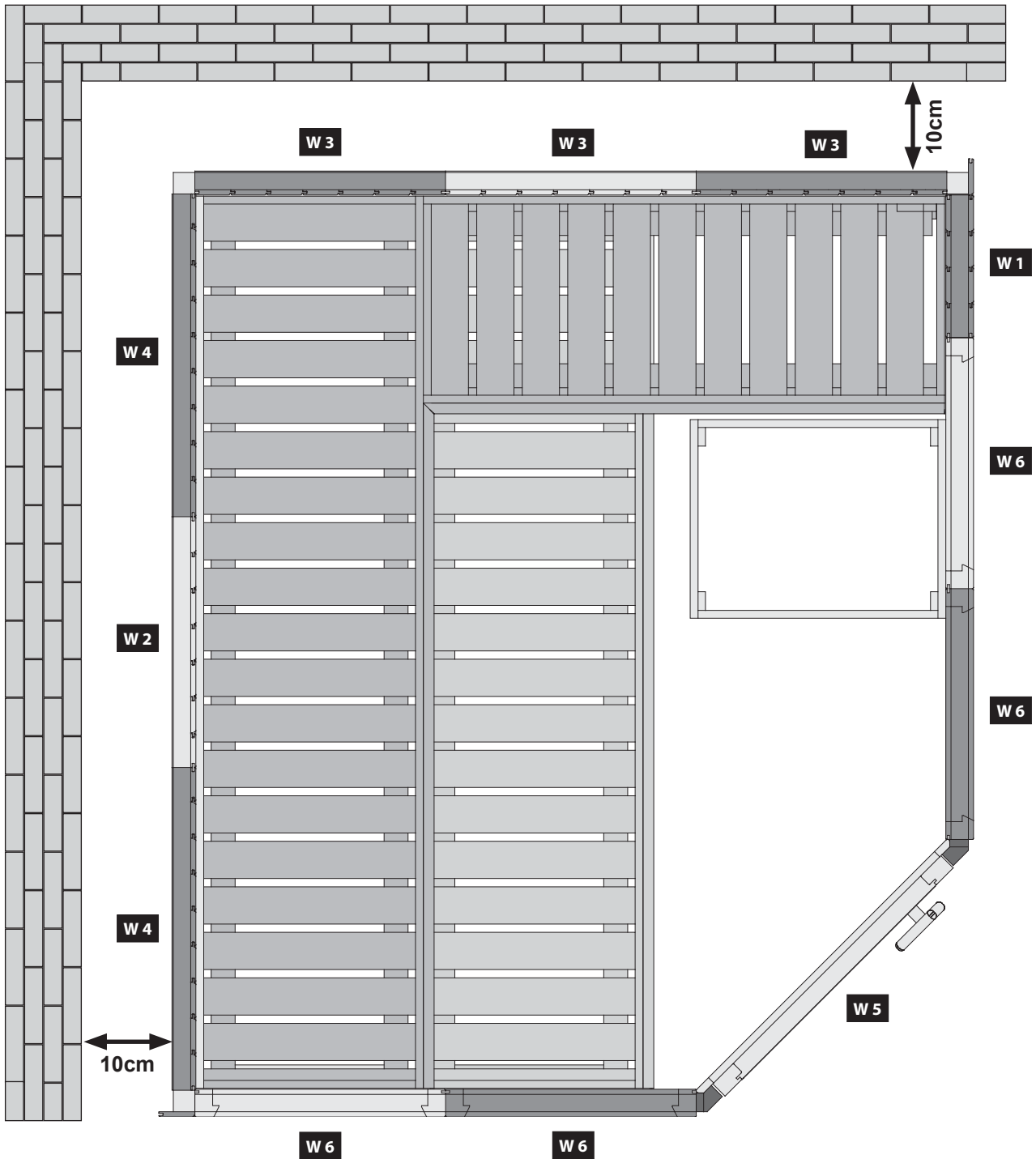
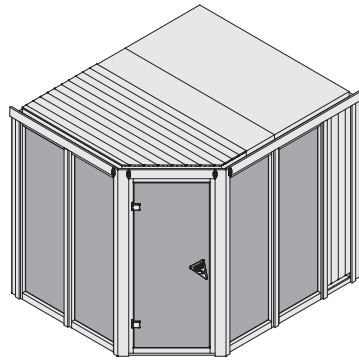

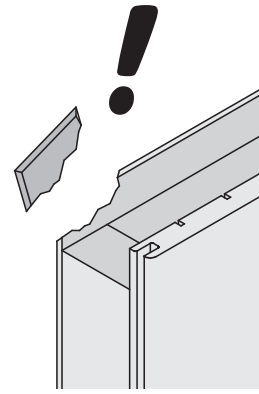
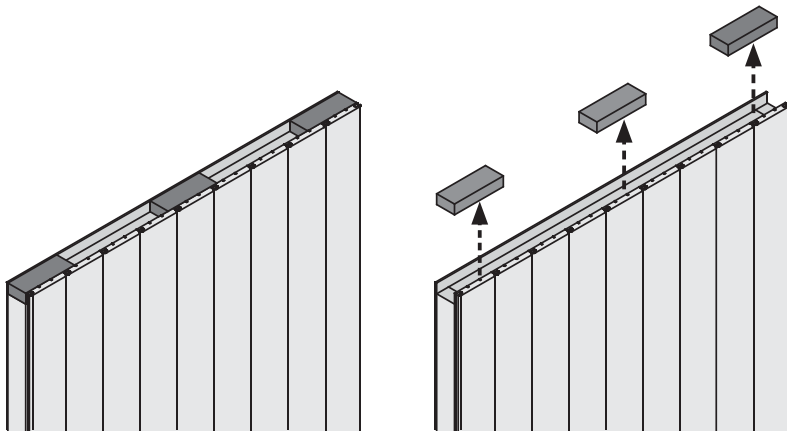

-  Vorsicht!
-  Voorzichtig!
-  Attention!
-  Attention!
-  Cuidado!
-  Occhio!
-  Pozor!
-  Opozorilo!

01

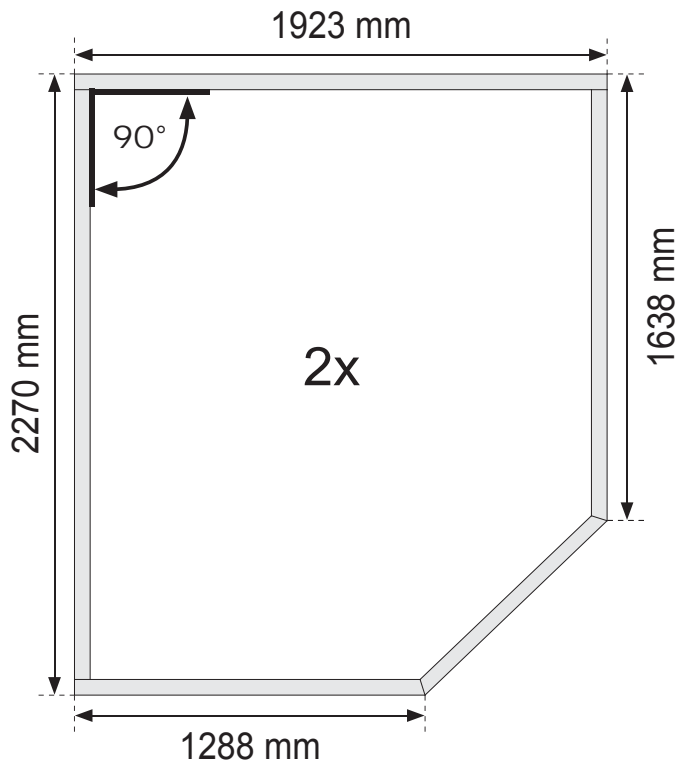

10x

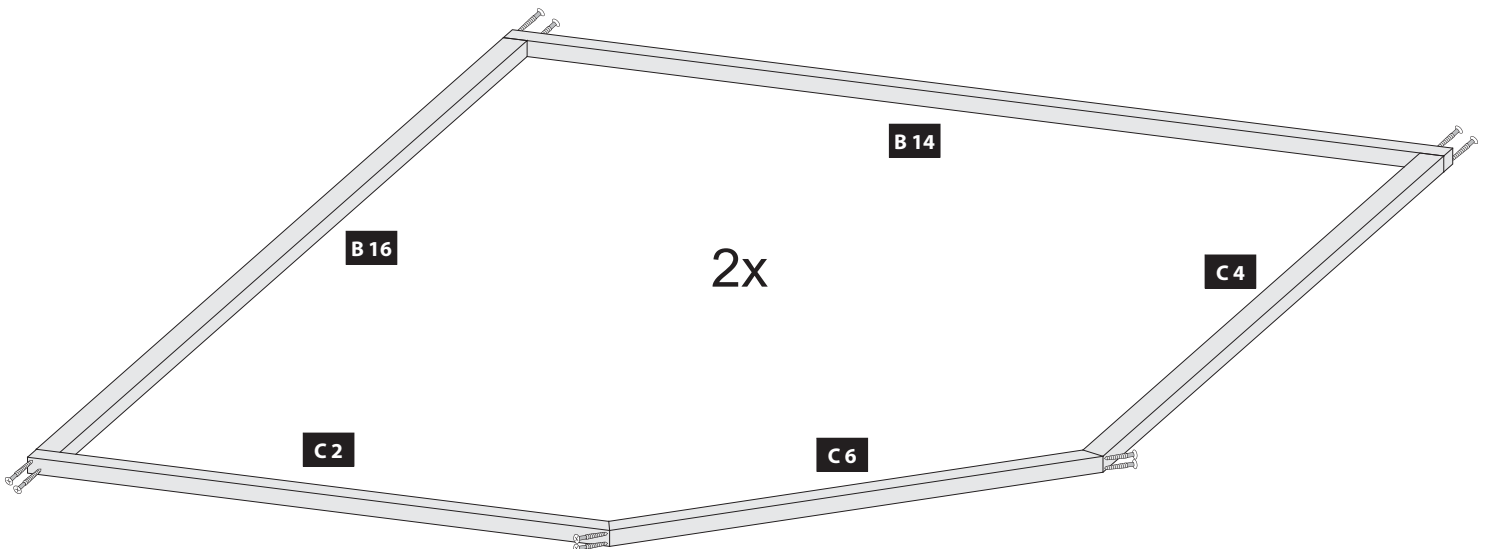
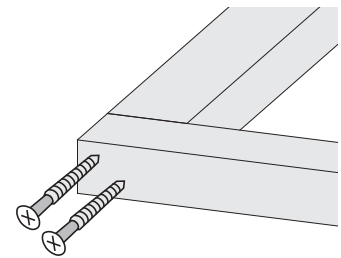
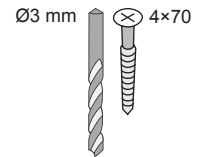

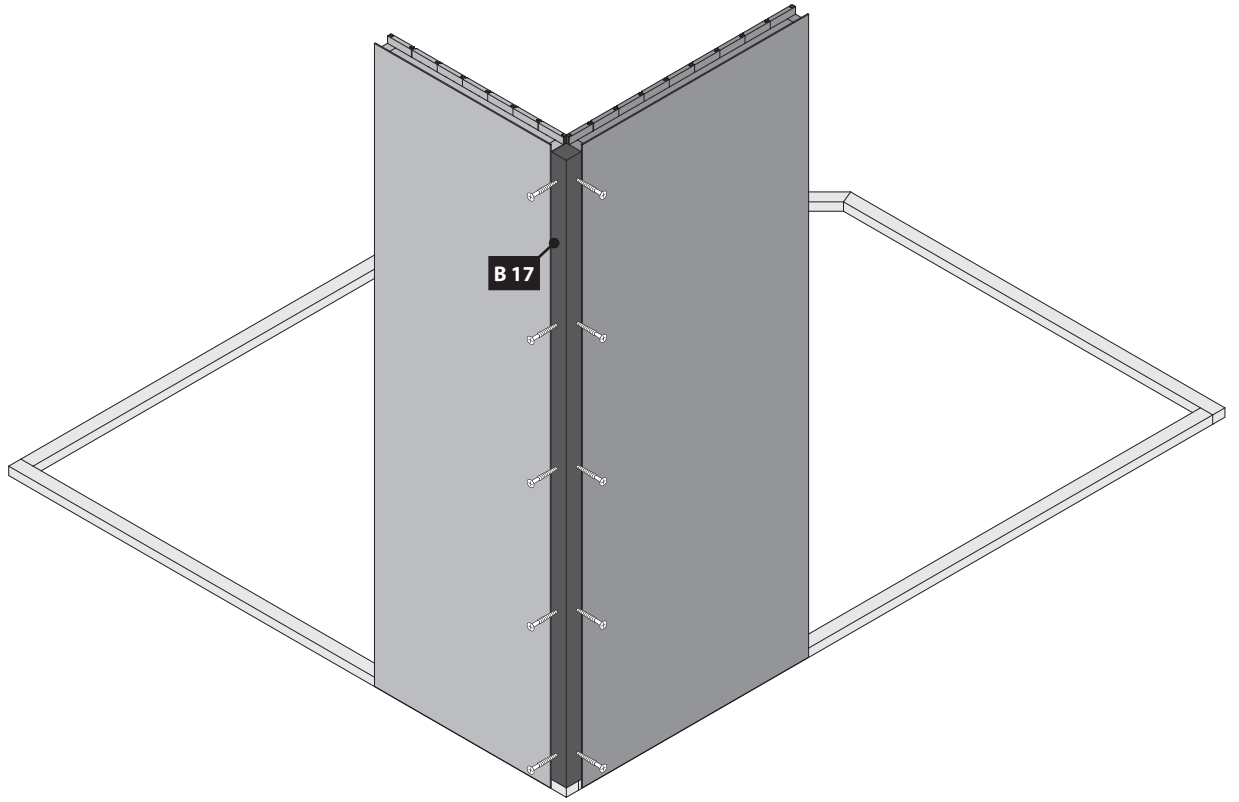

10x

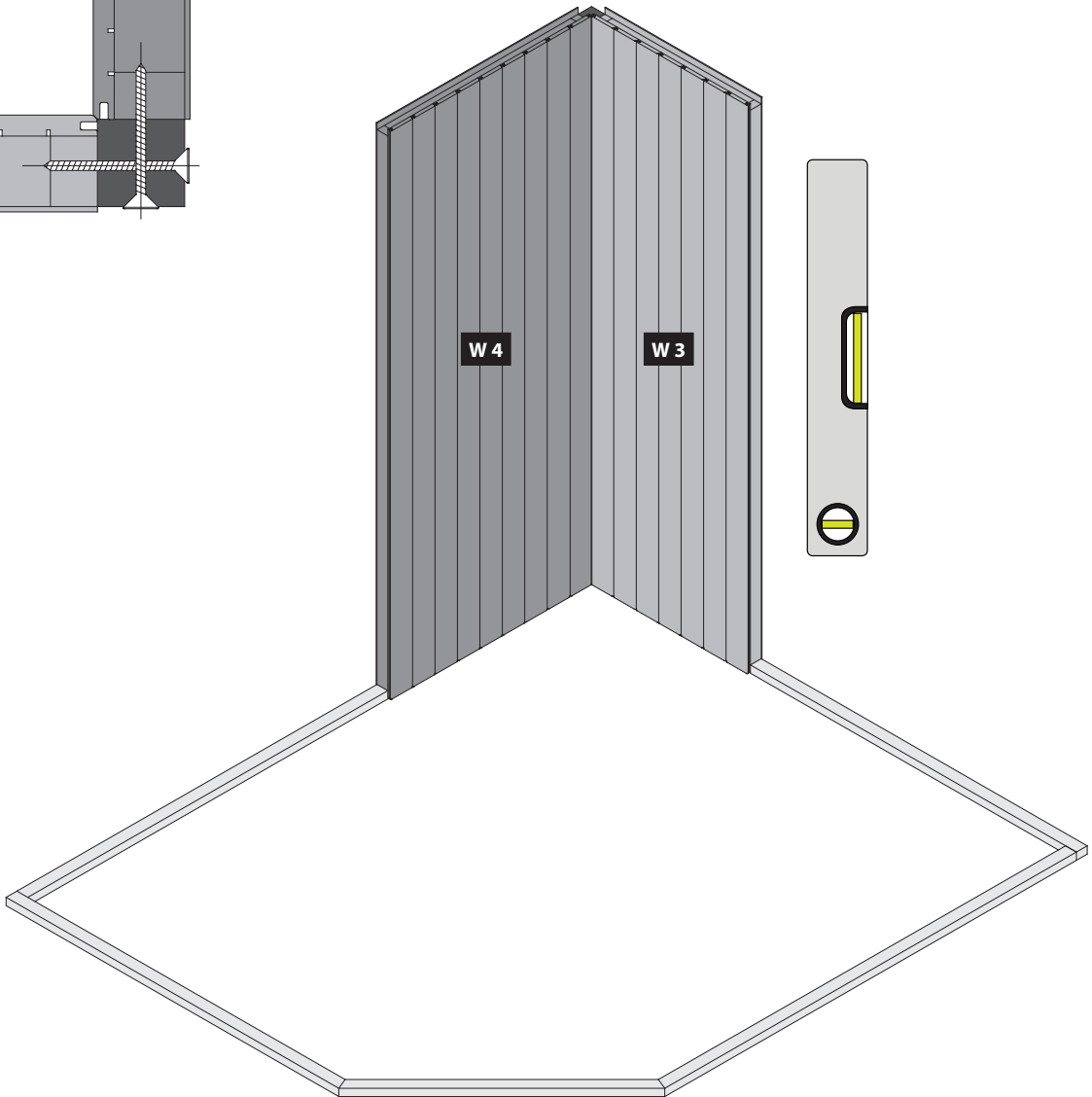
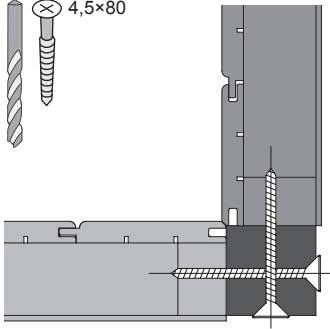
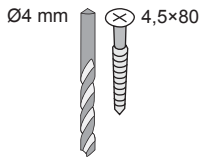

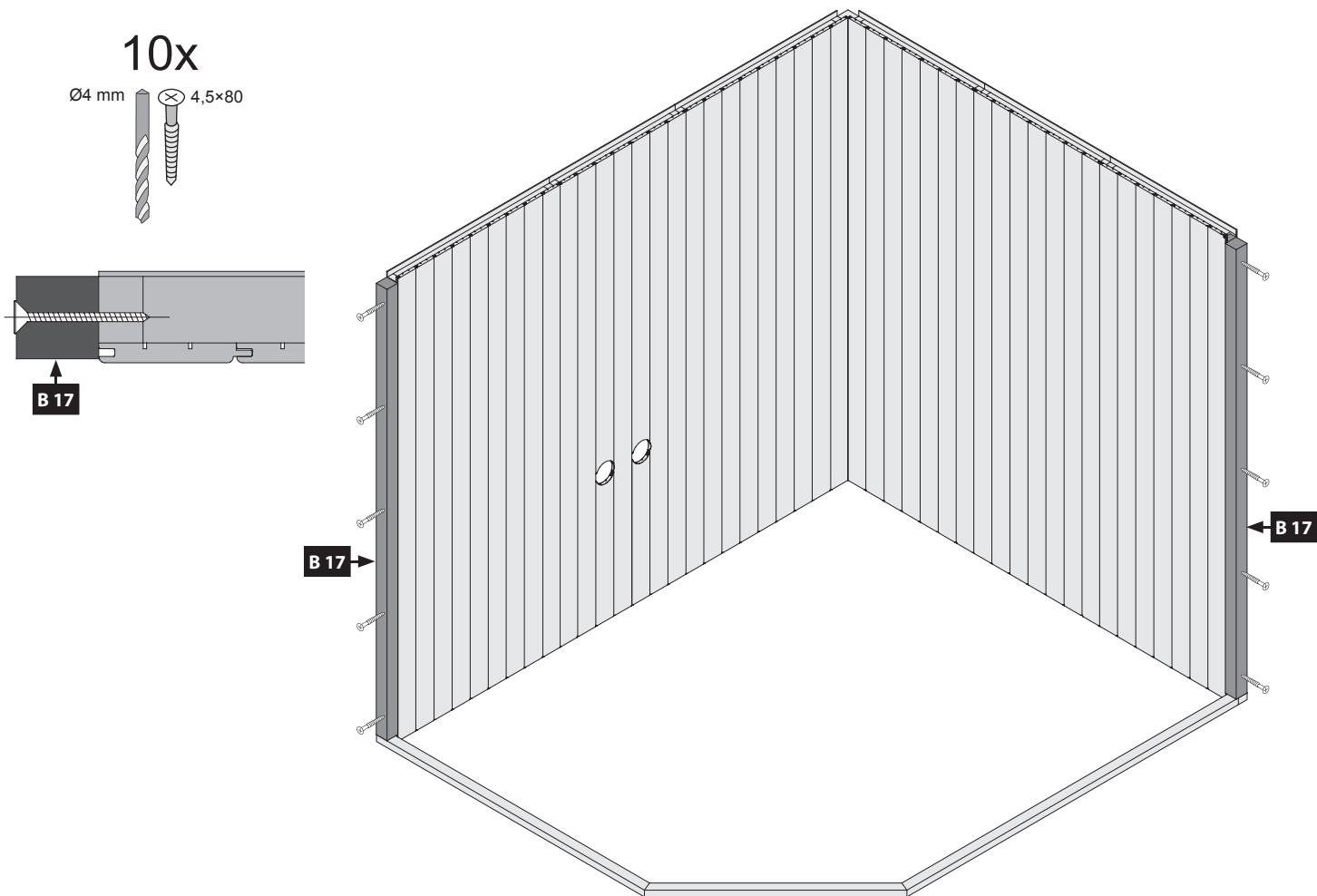
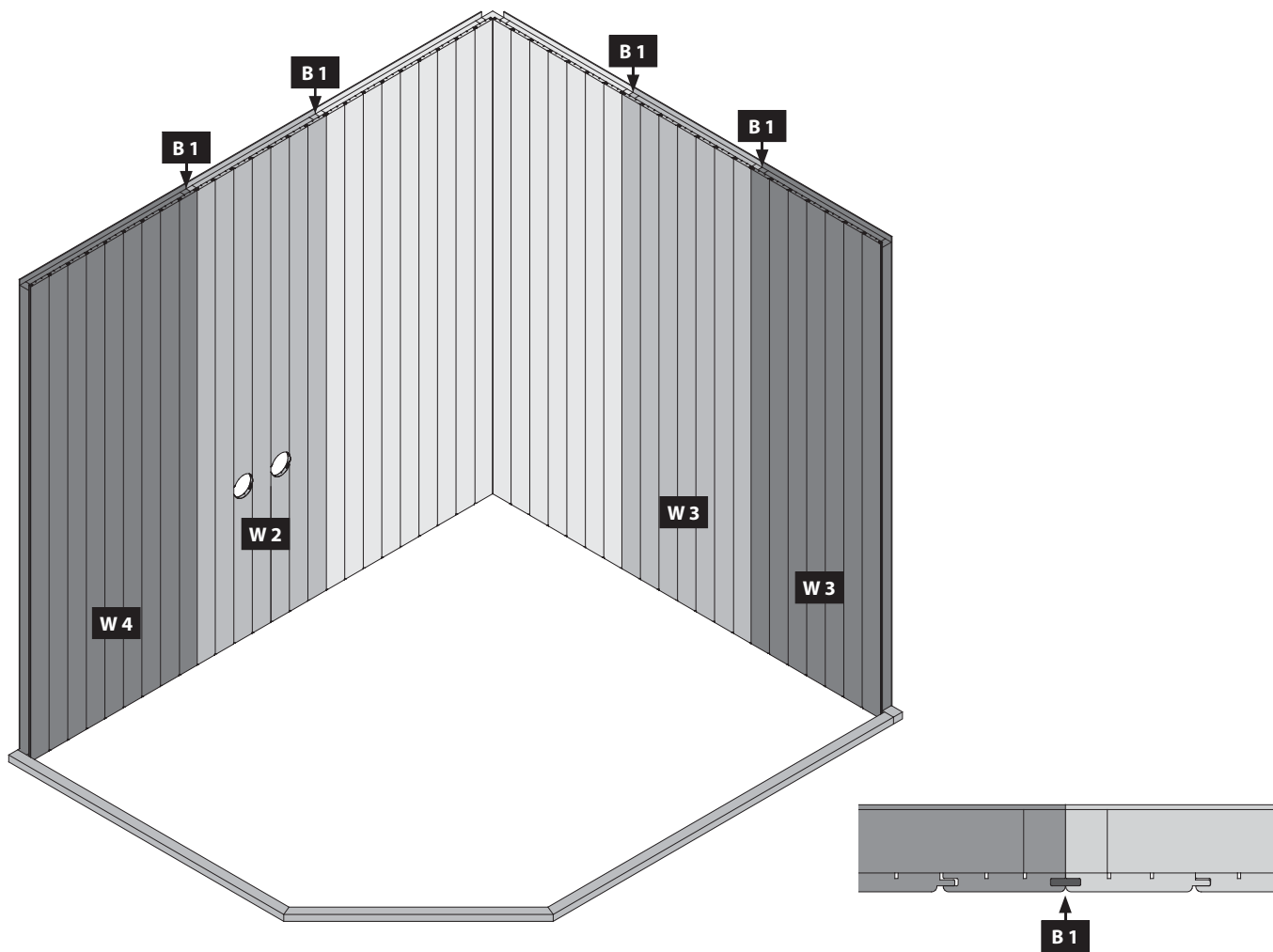

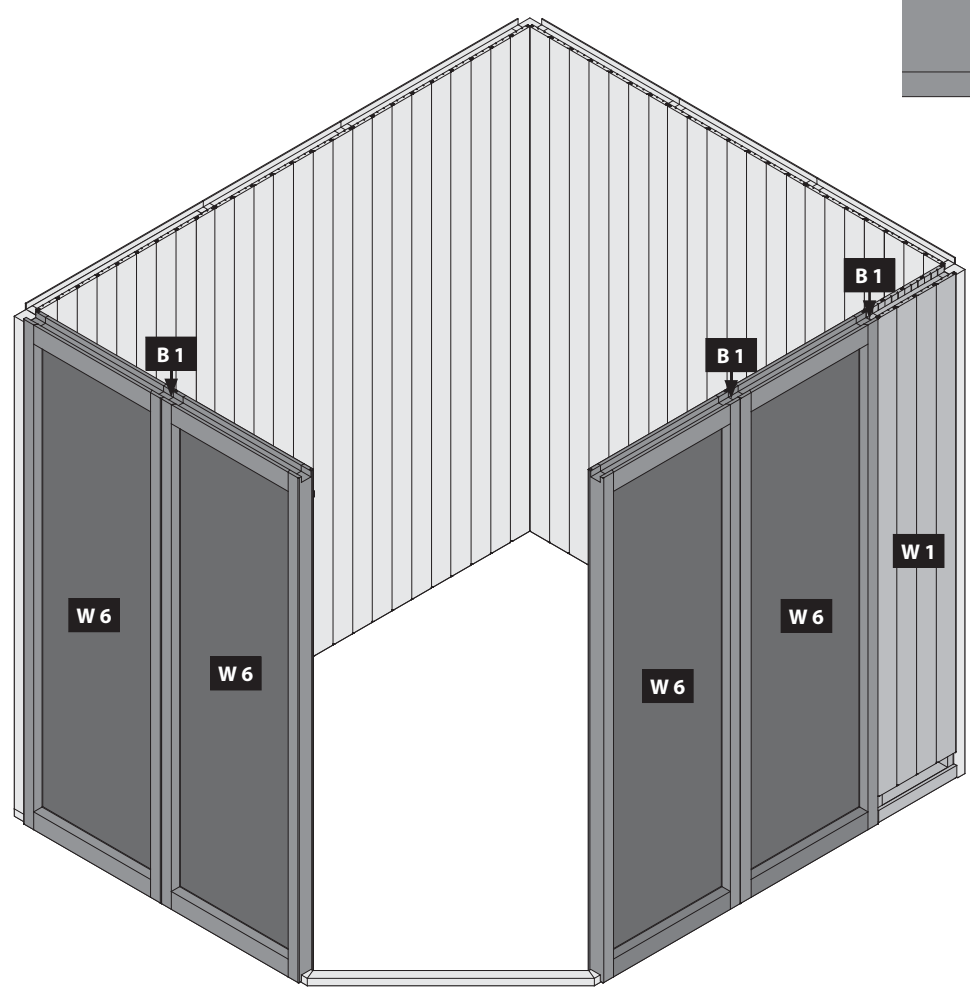
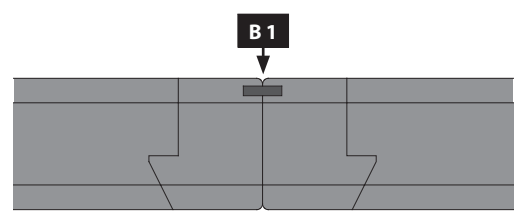
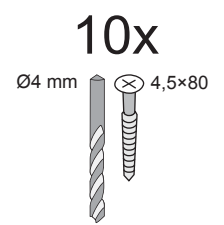
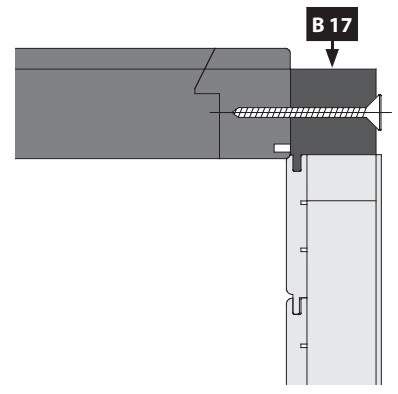
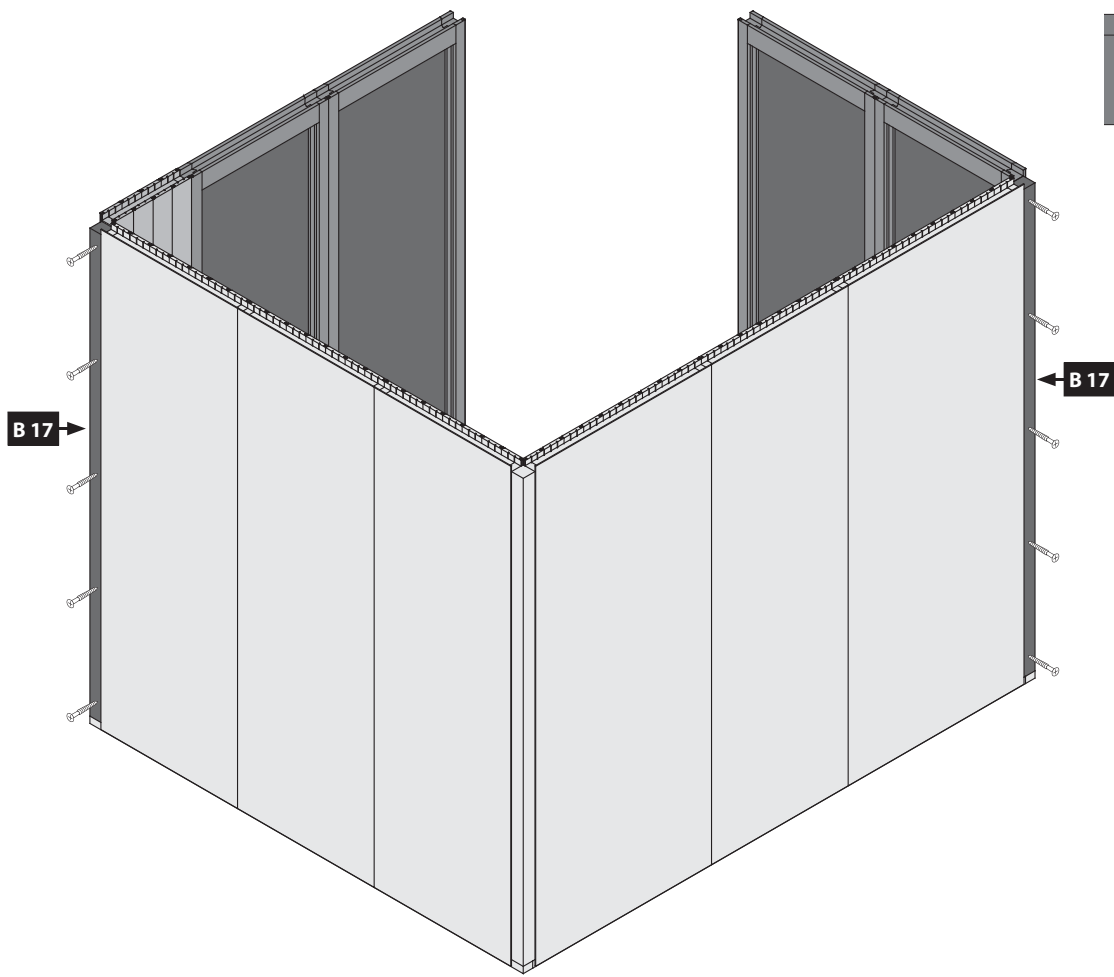

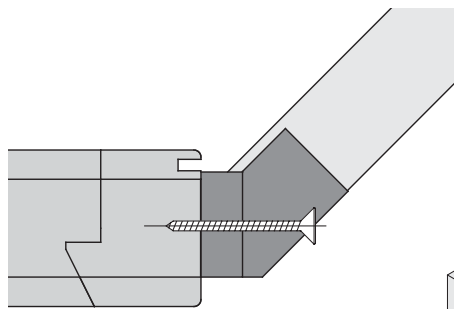

10x

Ø4 mm

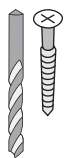

4,5x80

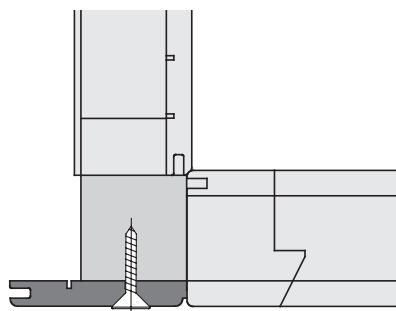
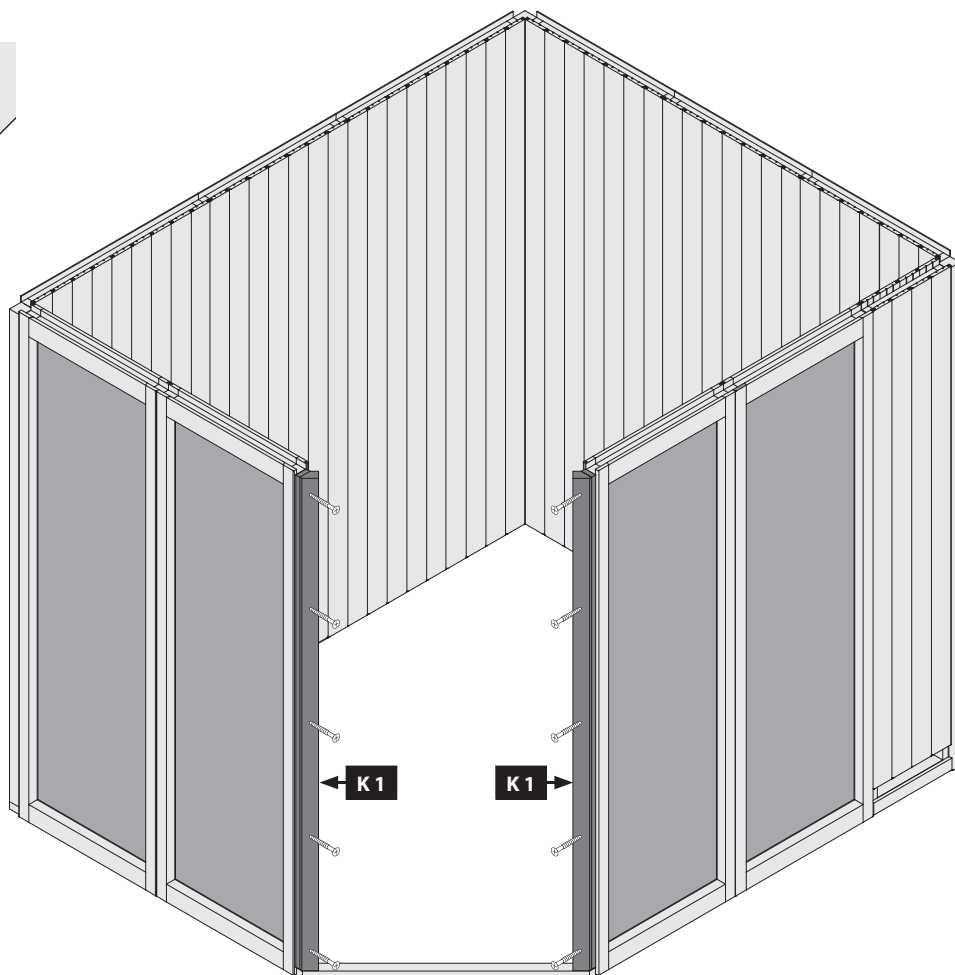

8x



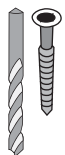

Ø4 mm

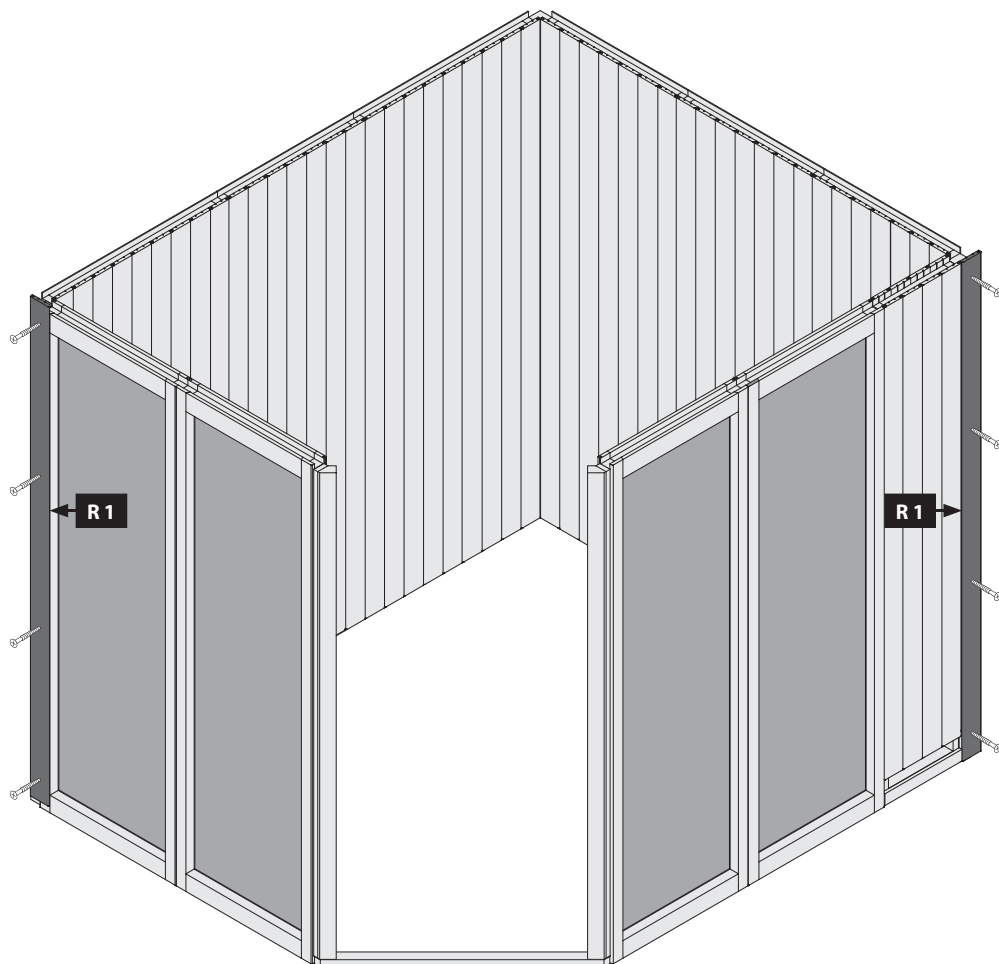

4,5x40



-  Einbau Glastür
-  Installation of glass door
-  Montage porte en verre
-  Montage van de glazen deur
-  Installationsglasdør

-  Montaje de la puerta de cristal
-  Installazione portello di vetro
-  Sauna Instalace dveře
-  Vgradnja steklenih vrat

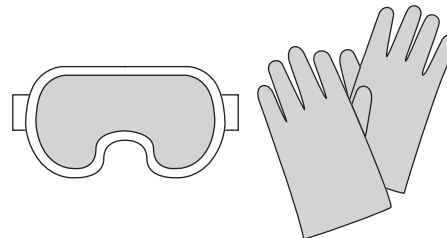

07



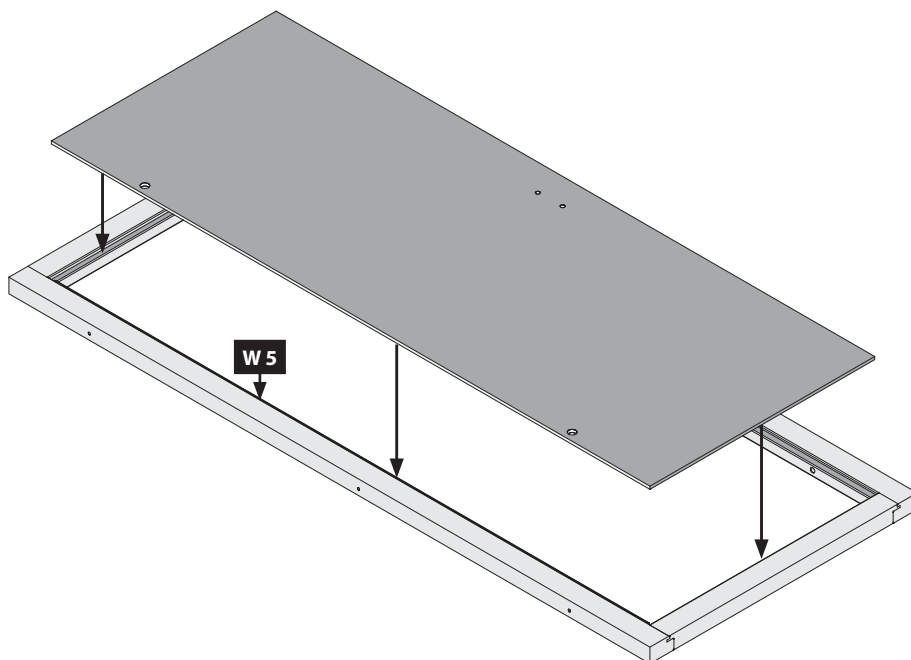

-  Tür in den Rahmen legen
-  Put the door in the frame
-  Mettez la porte dans le cadre
-  Plaats de deur in het frame
-  Sæt døren i rammen
-  Pon la puerta en el marco
-  Metti la porta nel telaio
-  Vložte dveře do rámu
-  Vrata namestite v okvir

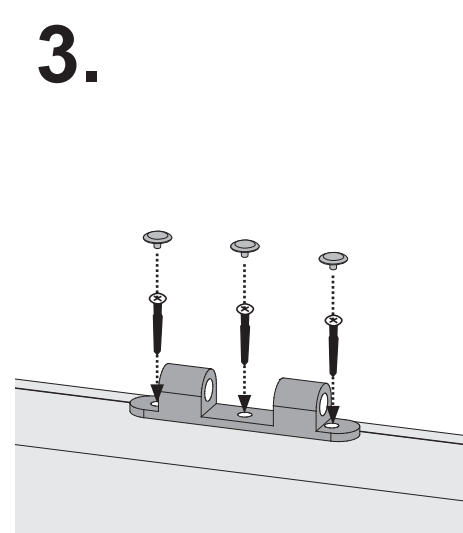
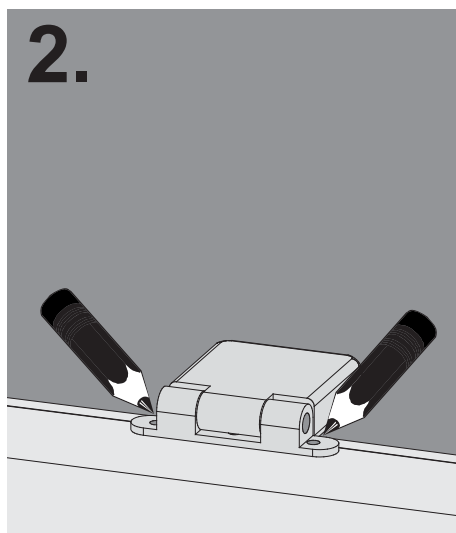
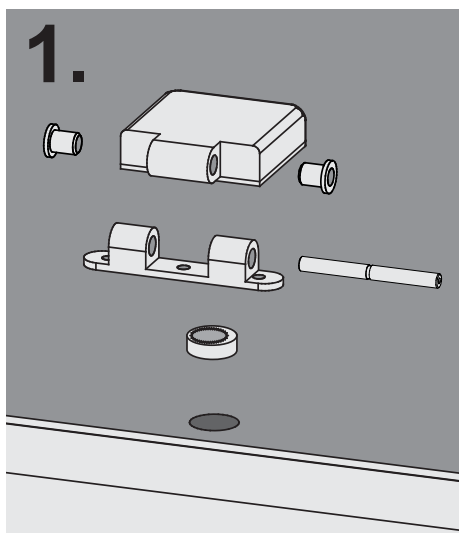
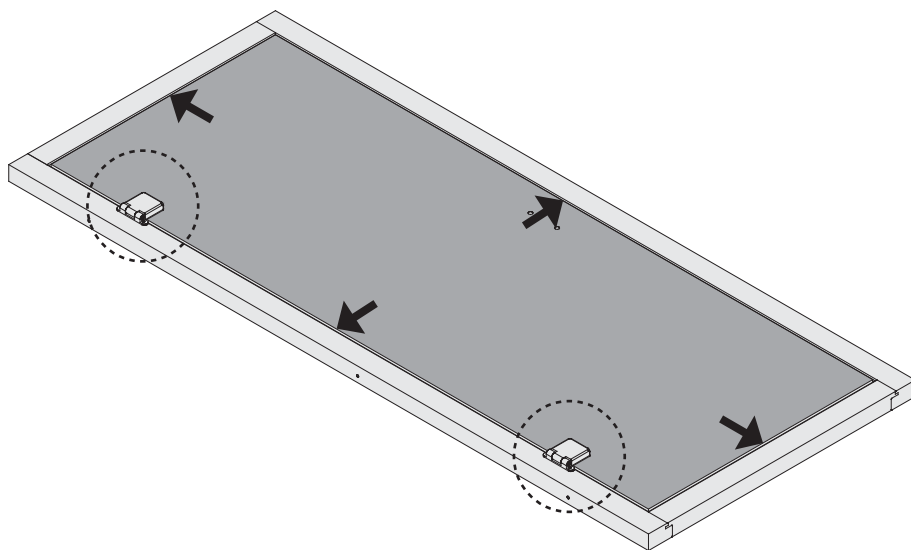

-  Tür im Rahmen ausrichten
-  Center the door in the frame
-  Aligner la porte dans le cadre
-  Lijn de deur in het frame uit
-  Juster døren i rammen
-  Alinea la puerta en el marco
-  Allinea la porta nella cornice
-  Zarovnejte dveře do rámu
-  Poravnajte vrata v okvir



-  Einbau Glastür
-  Installation of glass door
-  Montage porte en verre
-  Montage van de glazen deur
-  Installationsglasdør

-  Montaje de la puerta de cristal
-  Installazione portello di vetro
-  Sauna Instalace dveře
-  Vgradnja steklenih vrat

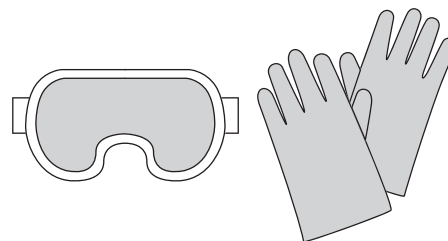

08

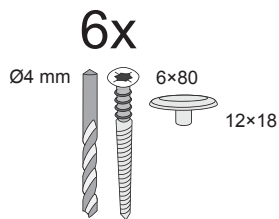
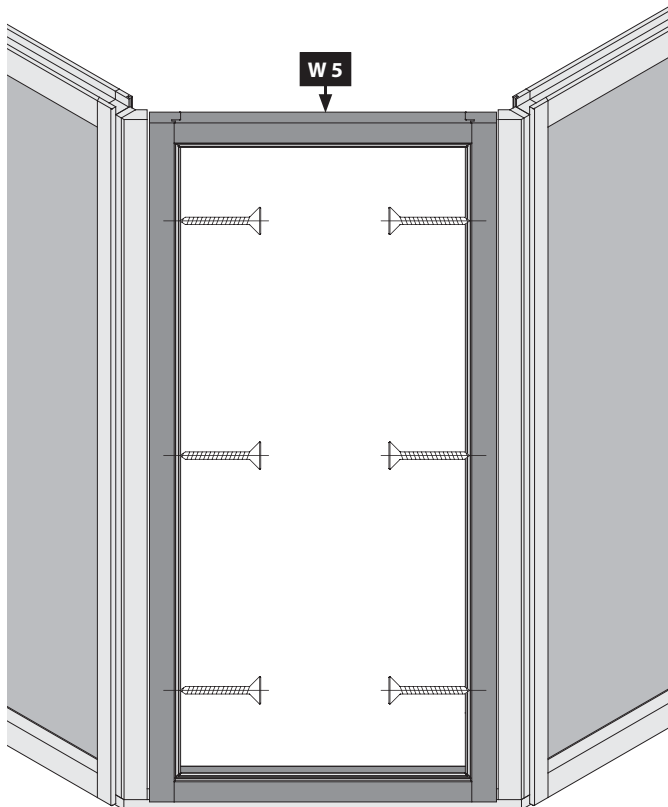

-  außen
-  outside
-  à l'extérieur
-  buiten
-  udenfor
-  fuera
-  al di fuori
-  vně
-  zunaj

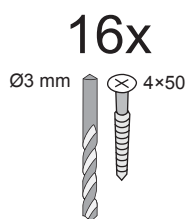
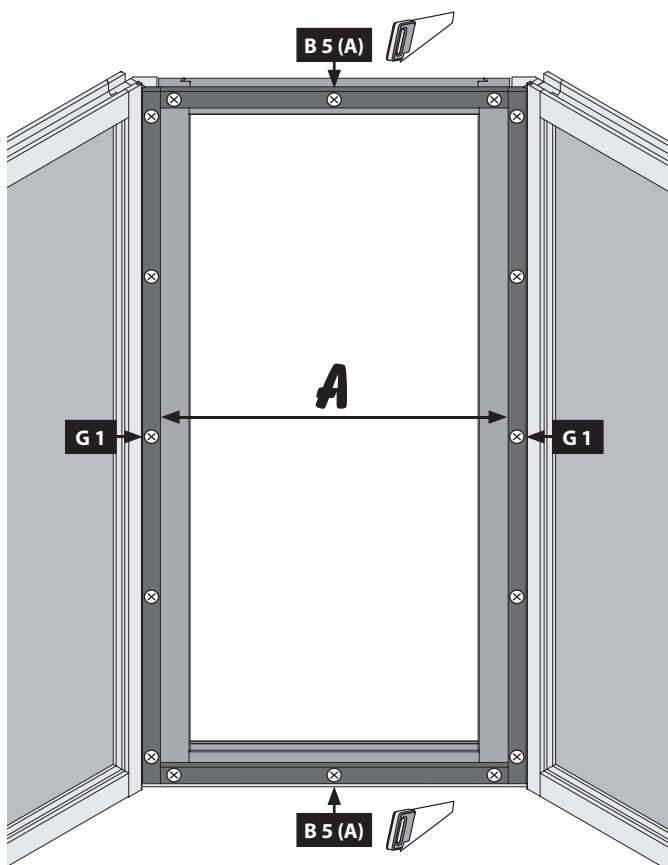
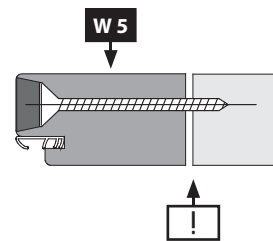
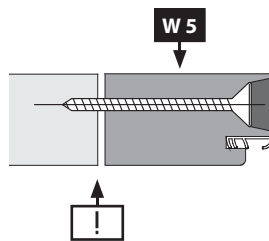

-  innen
-  Inside
-  à l'intérieur
-  inde på
-  binnen
-  dentro
-  dentro
-  uvnitř
-  znotraj

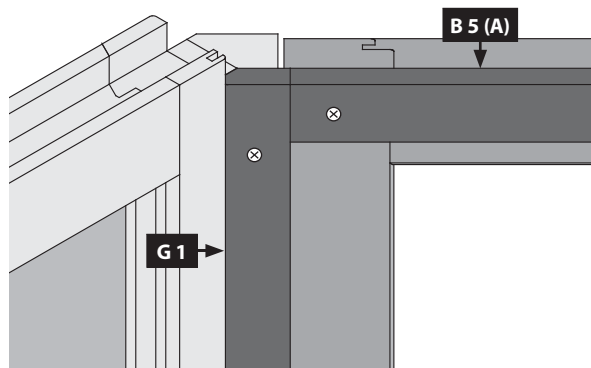

 Kabeldurchführung

 implementation for the cable

 mise en œuvre pour le câble

 implementatie voor de kabel

 Kabelforskruning

 implementación para el cable

 implementazione per il cavo

 provedení kabelu

 Kabelsko žrelo

09

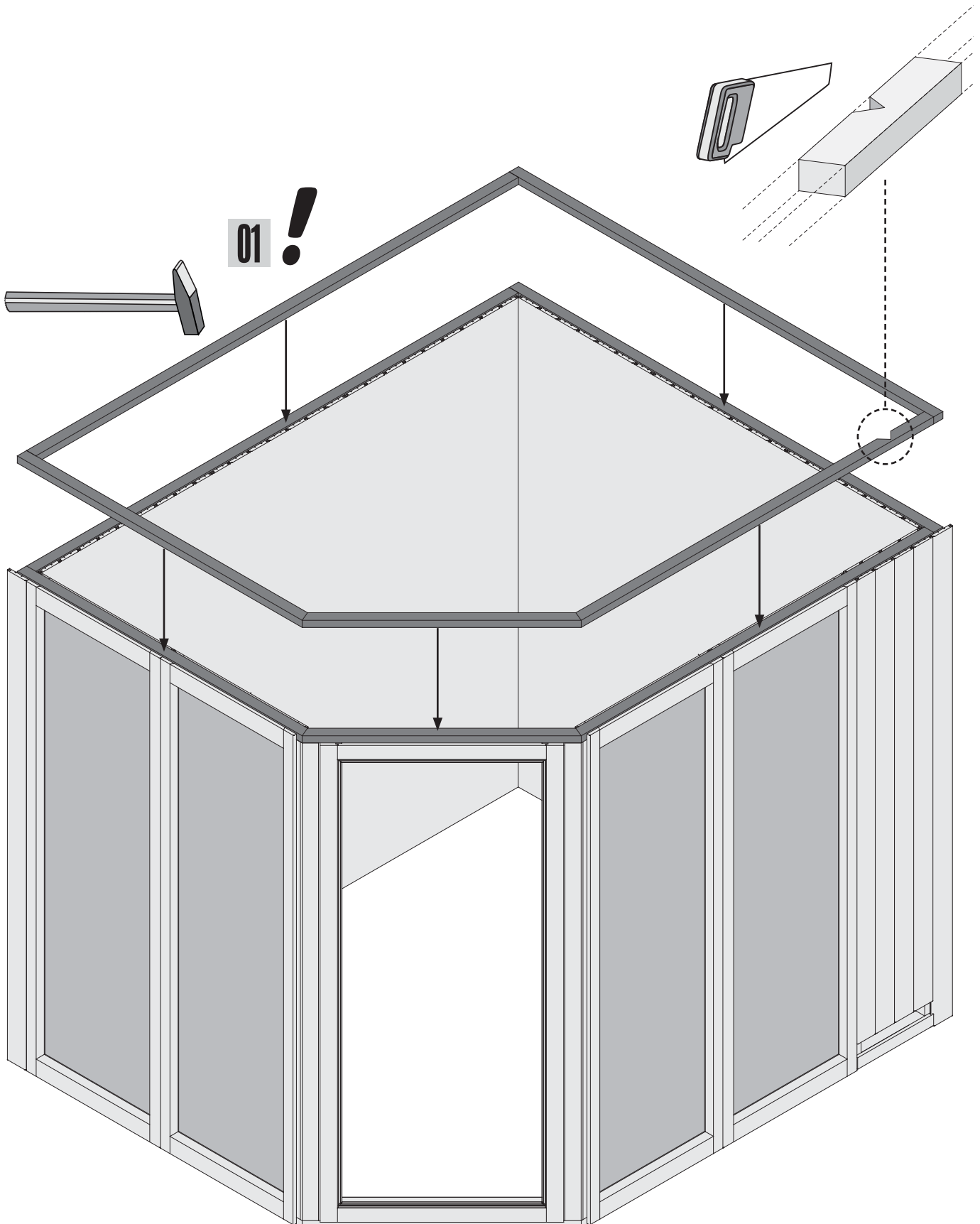



21x
Ø3 mm 4x50

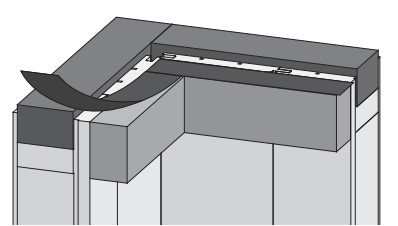
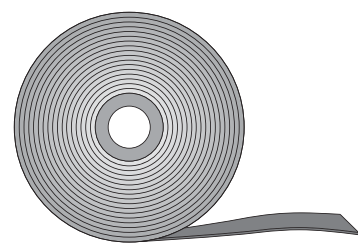
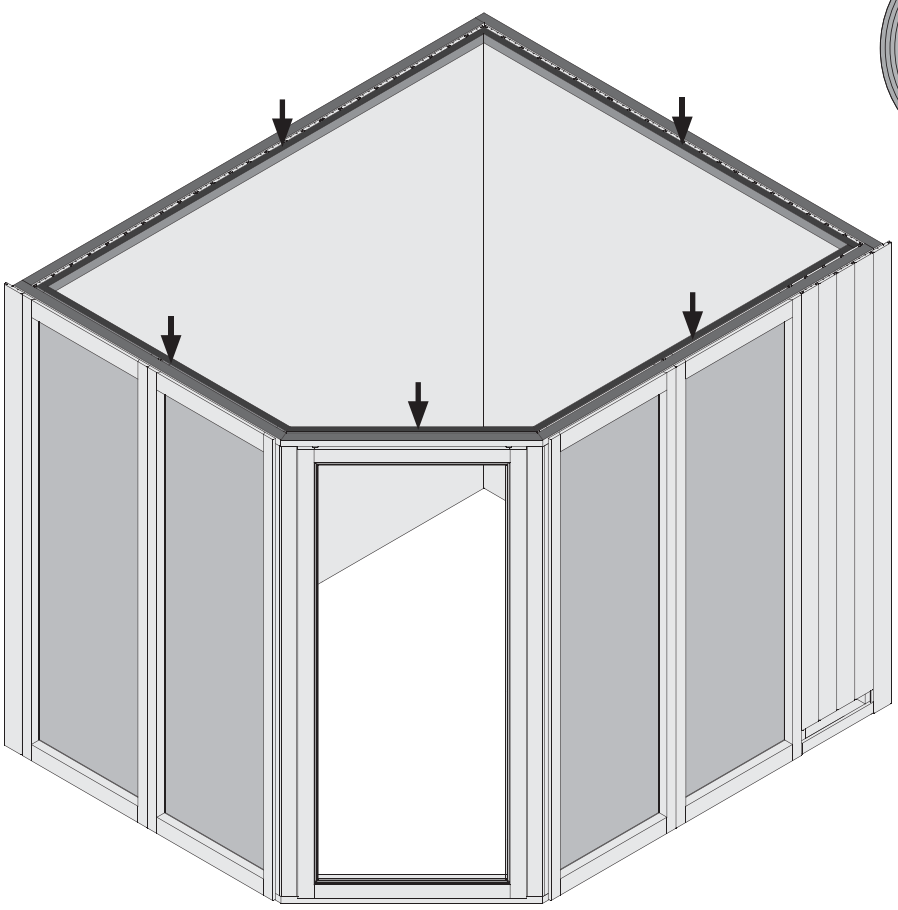
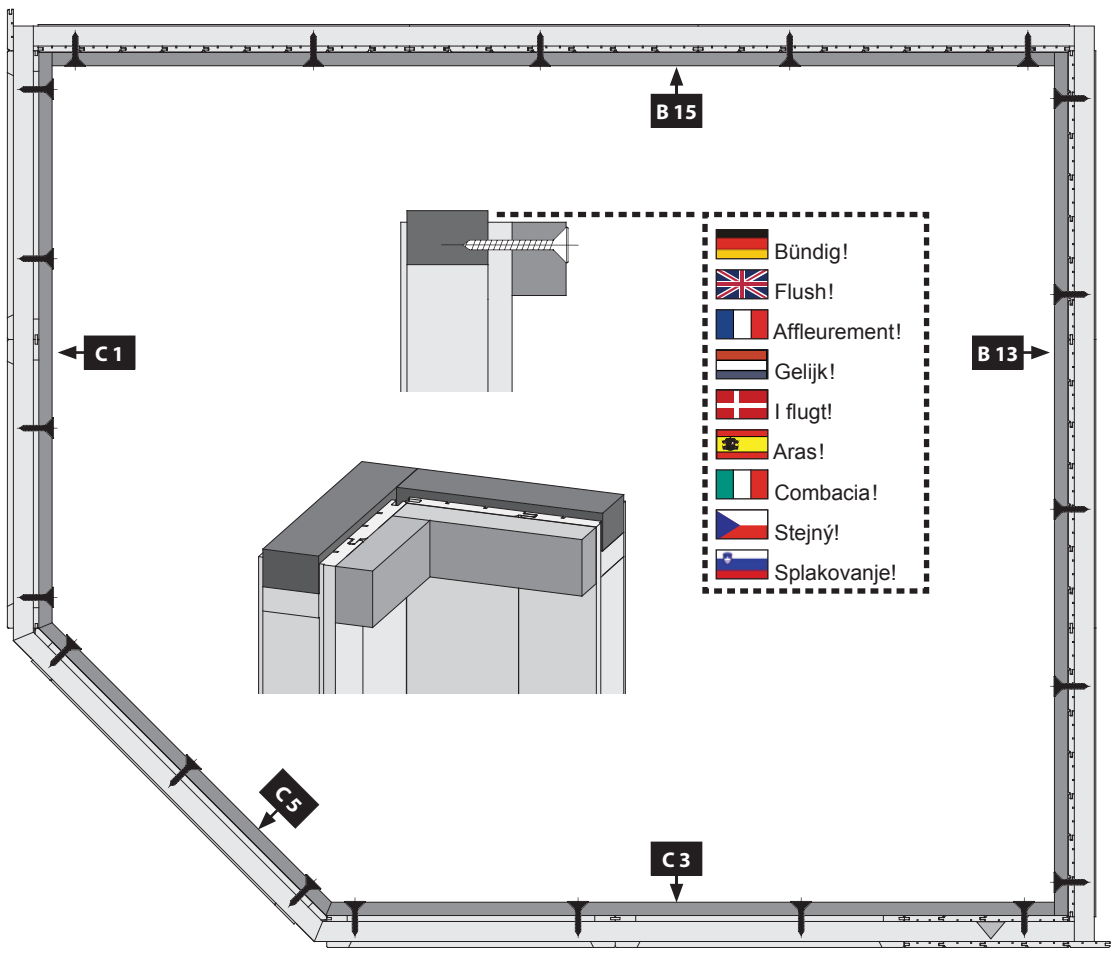

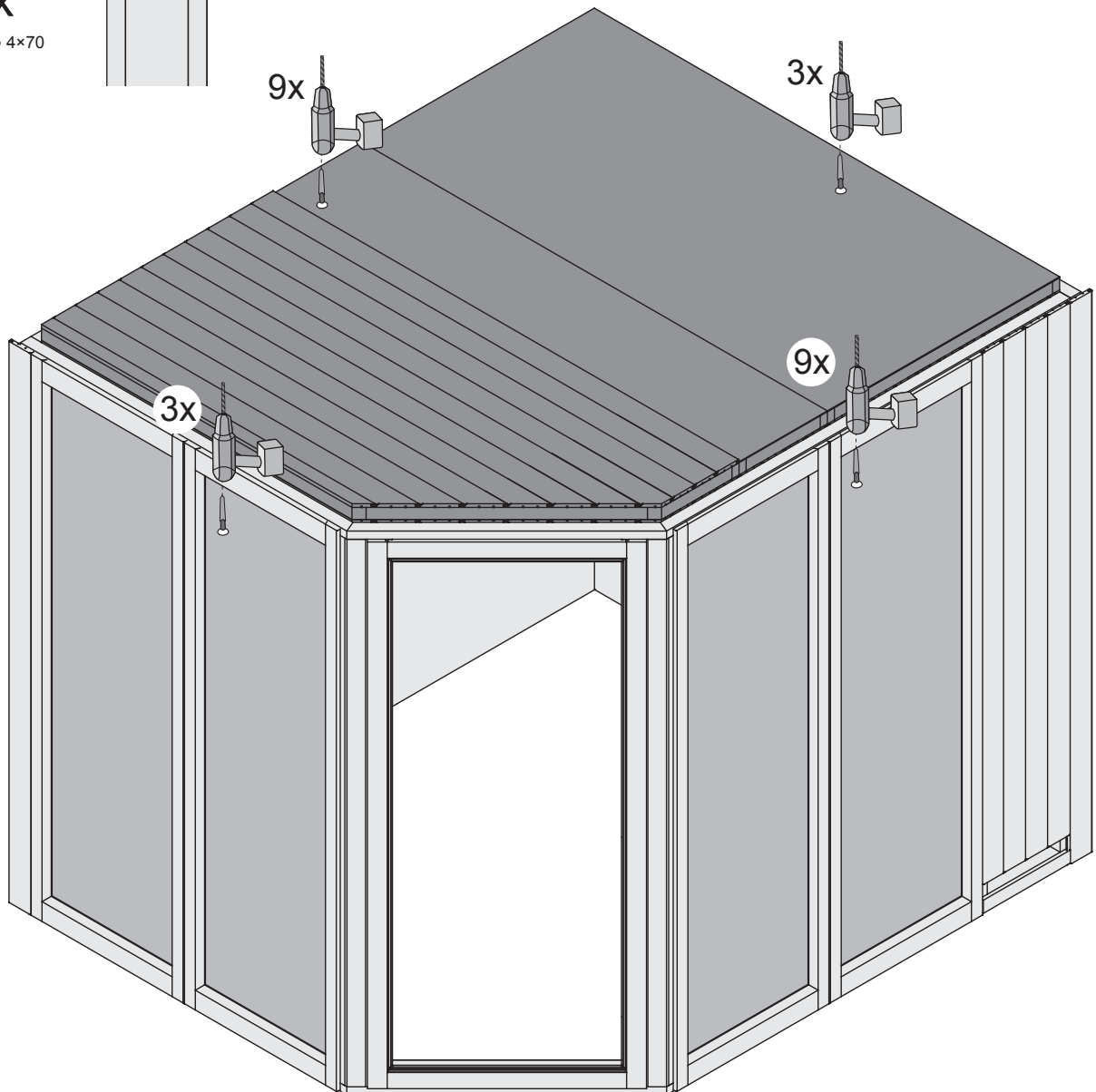
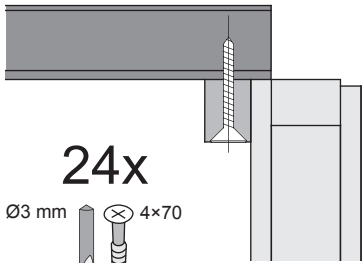
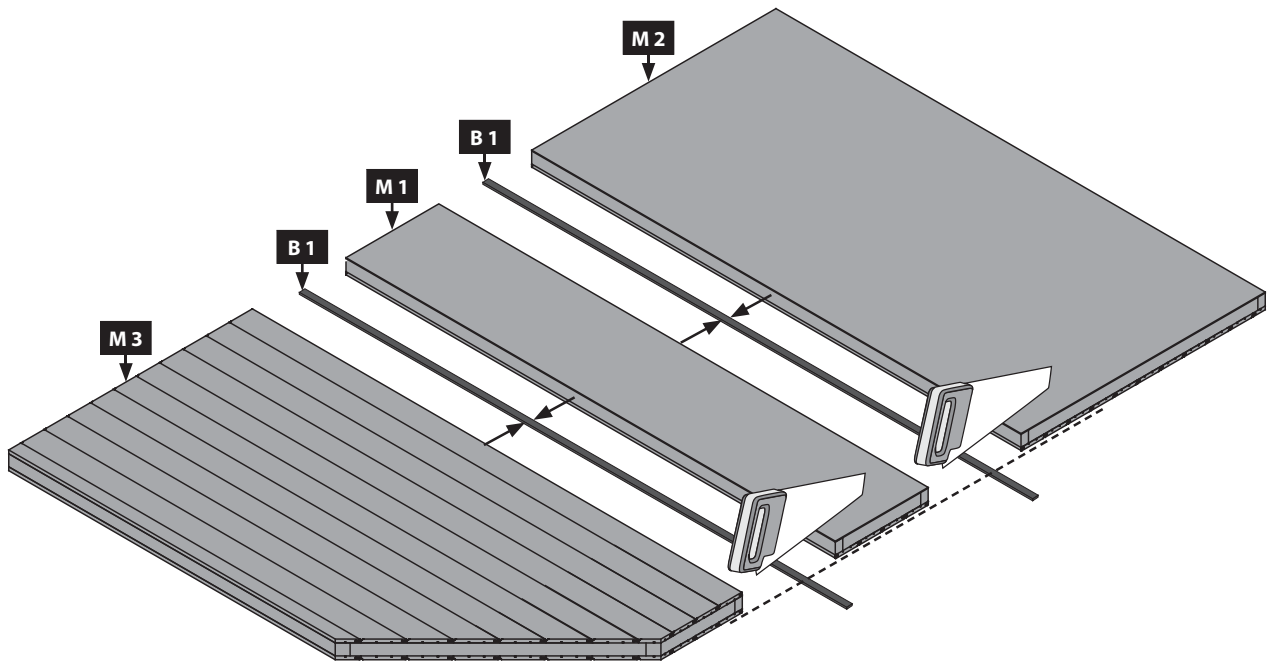



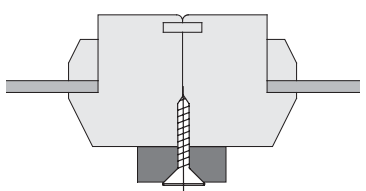
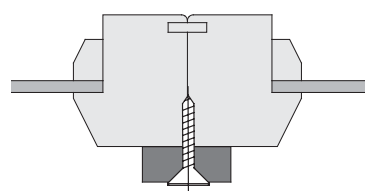
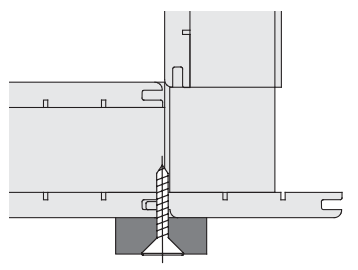
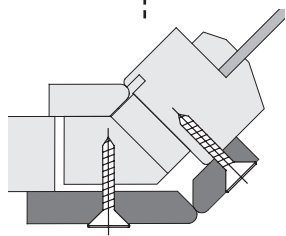
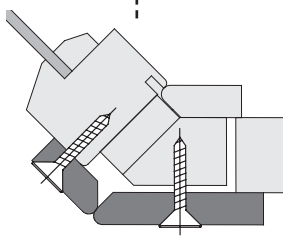
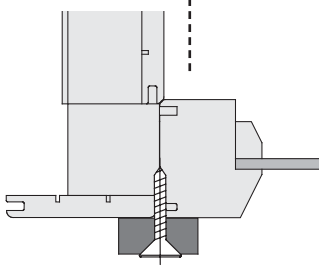
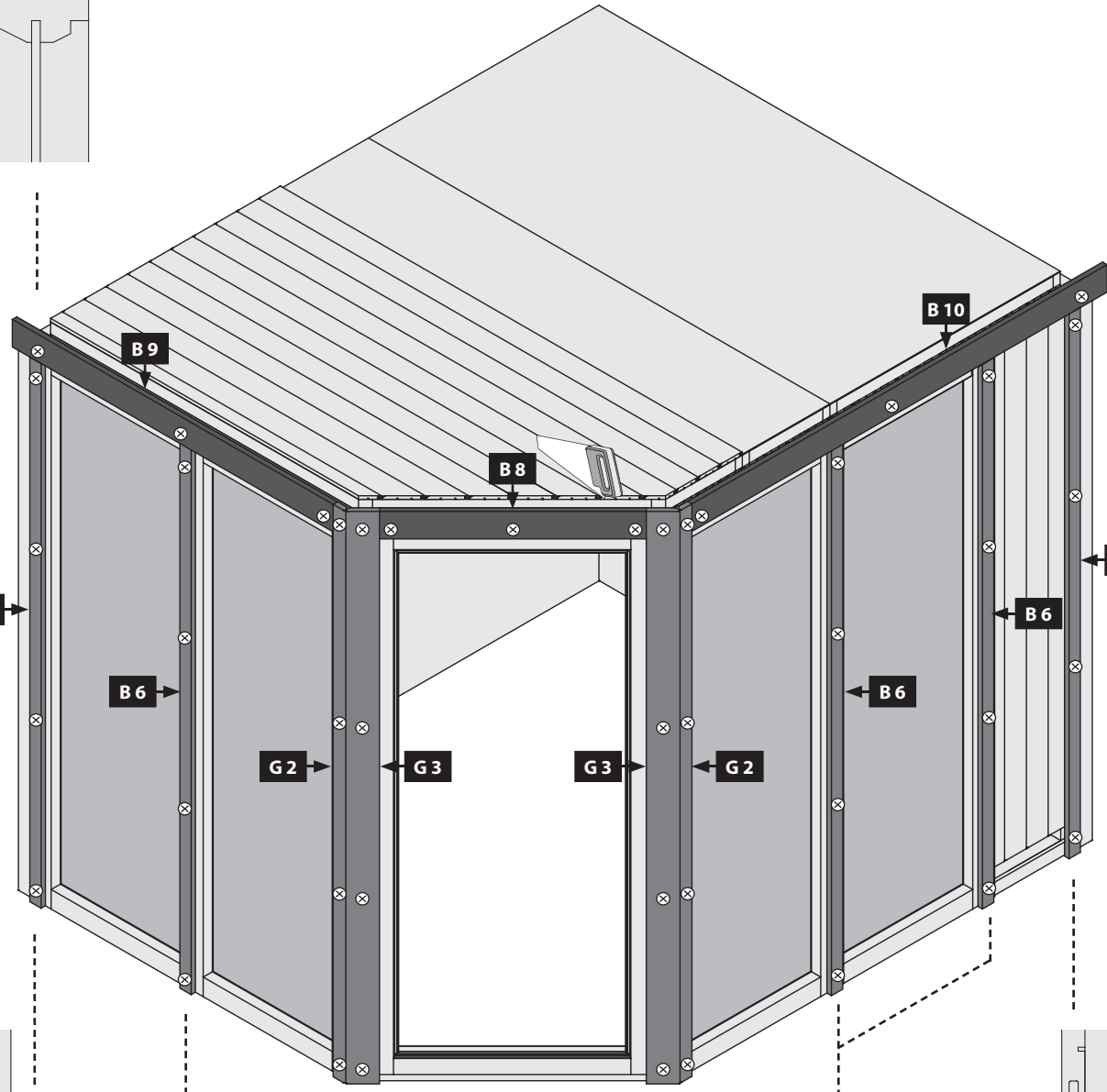
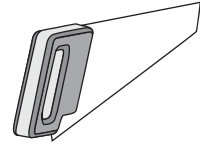
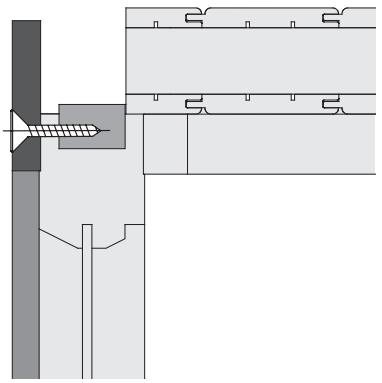
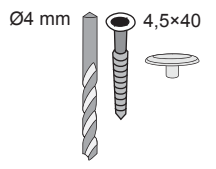

45x



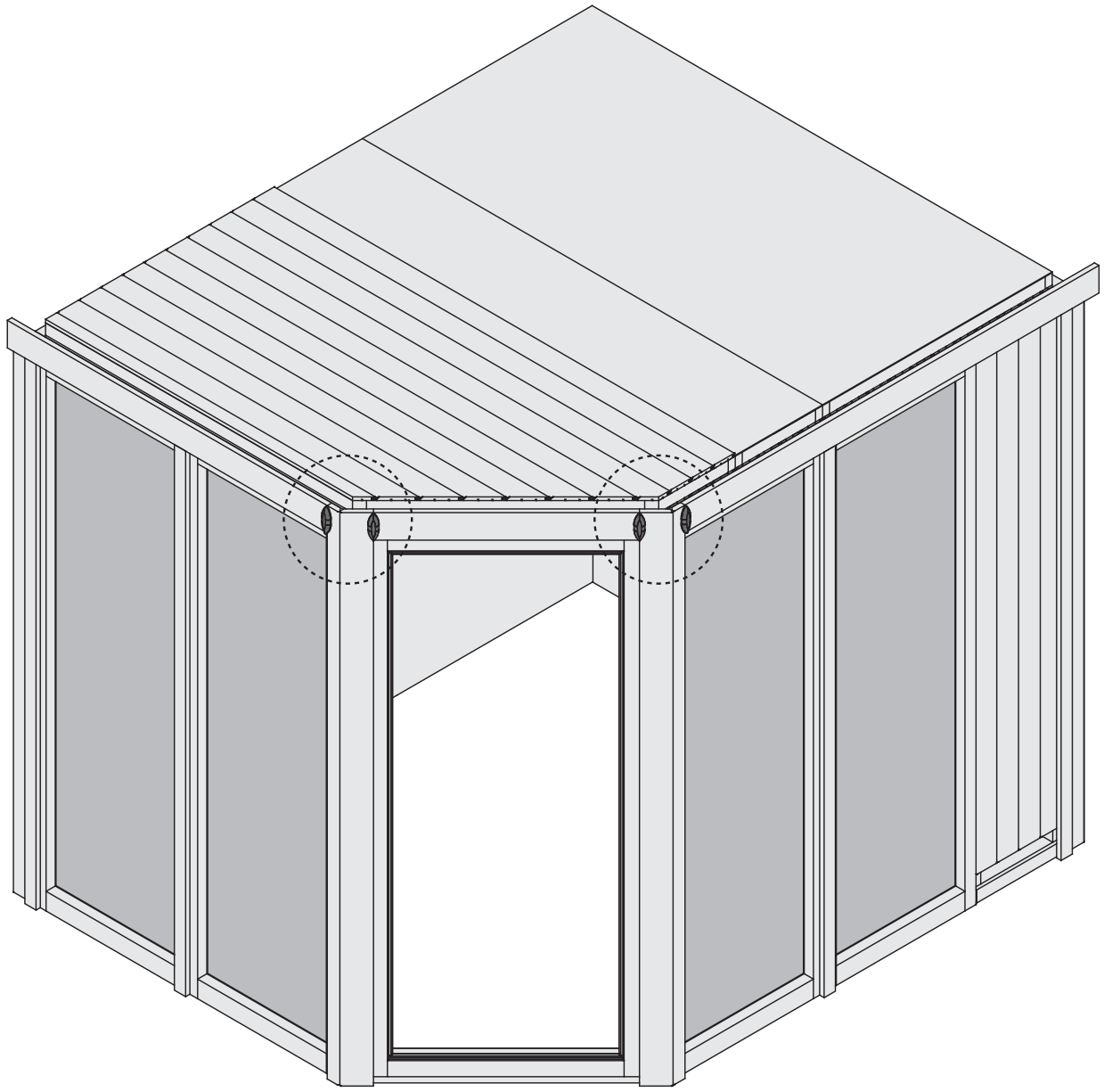
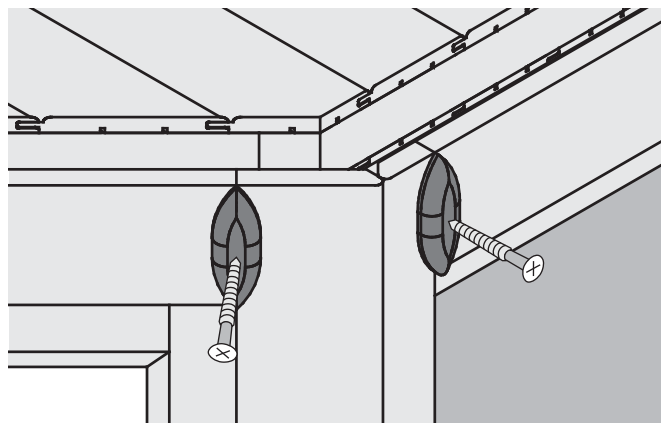

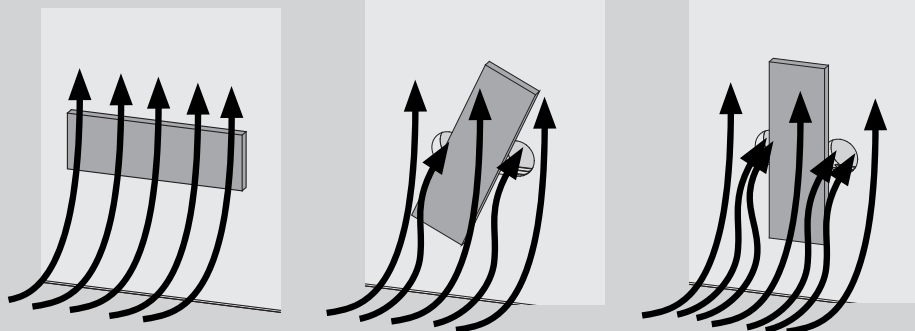
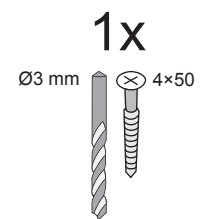
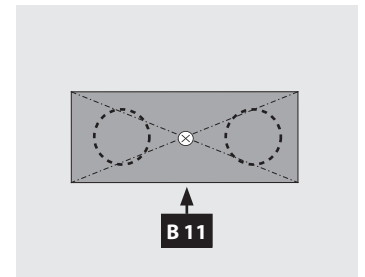
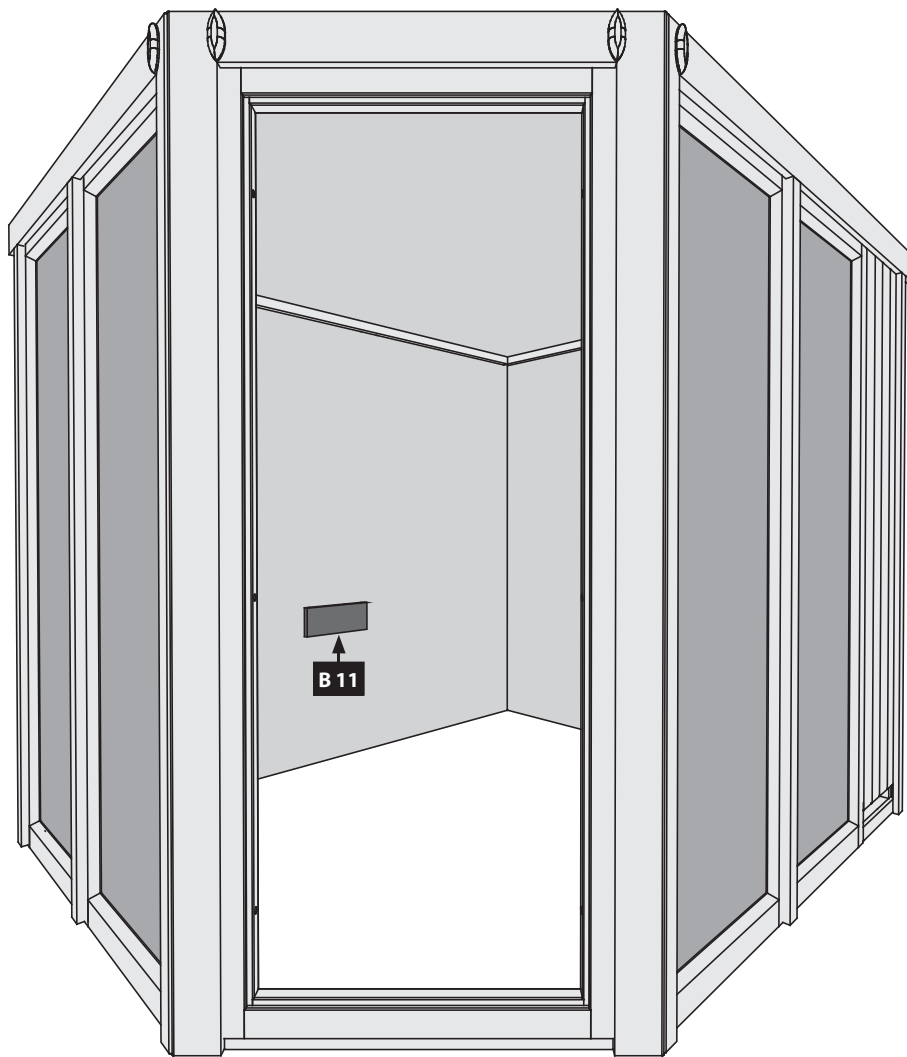
4x
Ø4 mm 4,5x40







 Hier ist die Funktionsweise des Brettes abgebildet. Regeln Sie damit die Abluft nach Ihren eigenen Wünschen

 This figure shows the functional principle of the board. Regulate the exhaust air according to your own wishes

 Ceci représente le mode de fonctionnement de la planche. Avec elle, réglez l'écoulement de l'air selon vos désirs.

 Hier is de werking van het plankje afgebeeld. Regel daarmee de luchtafvoer naar eigen wens

 Sådan fungerer styret. Brug den til at regulere udstødningsluften efter dine egne ønsker

 Aquí está representada la forma de funcionamiento de la tabla. Regule con ello el aire de salida según sus propios deseos

 Viene illustrato il principio di funzionamento della tavoletta di regolazione della ventilazione. Con essa si può regolare a piacere la ventilazione

 Zde je zobrazená funkce desky. Regulujte s ní odsávací vzduch dle Vašeho přání

 Tukaj si lahko ogledate delovanje plošče. Z njo lahko uravnavate izpušni zrak po lastnih željah.

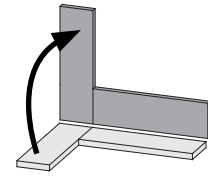
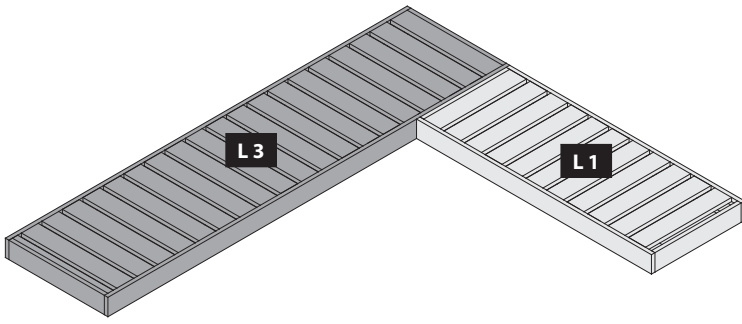

15

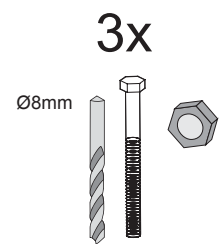
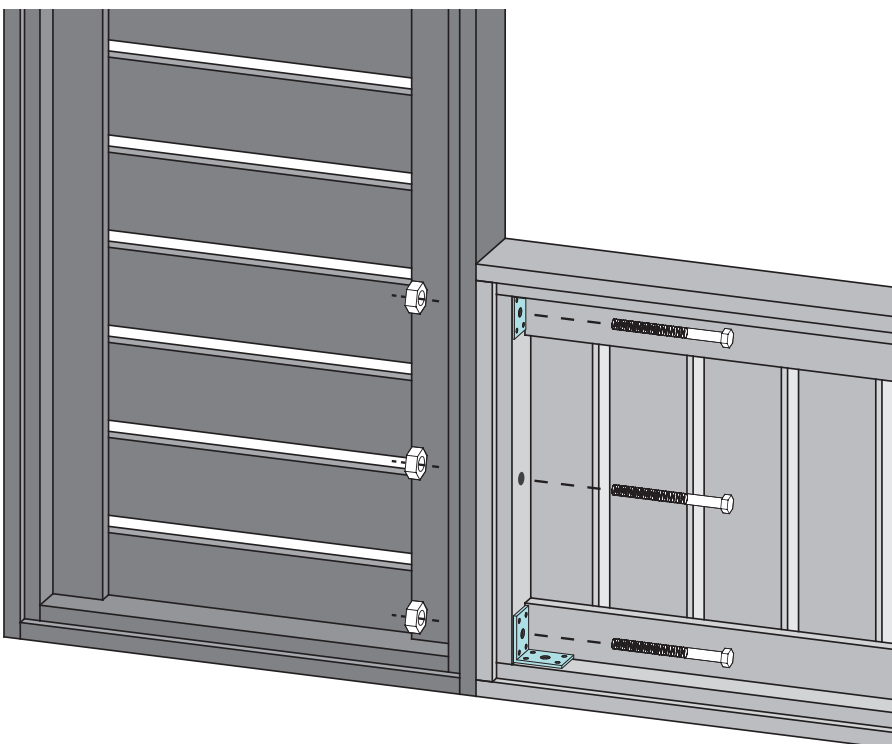
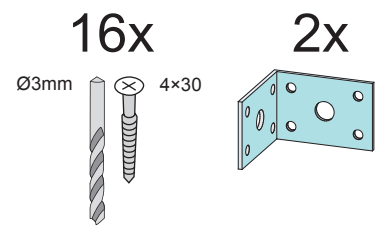
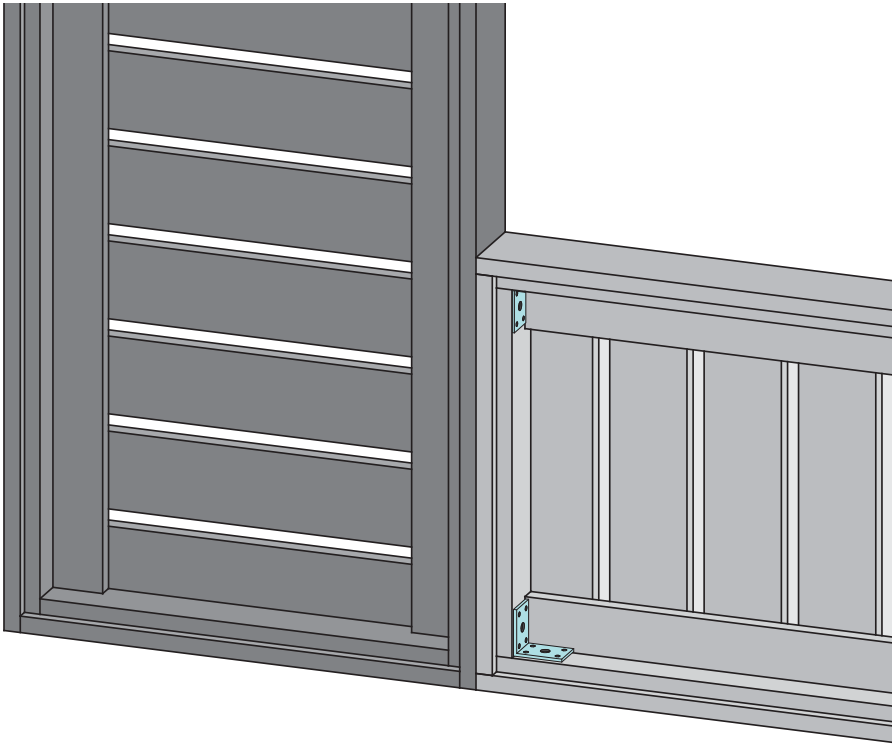

-  Ansicht unten
-  View below
-  Voir ci-dessous
-  Bekijk hieronder
-  Se nedenfor
-  Ver abajo
-  Visualizza sotto
-  Zobrazit níže
-  Oglejte si spodaj

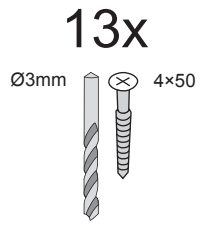
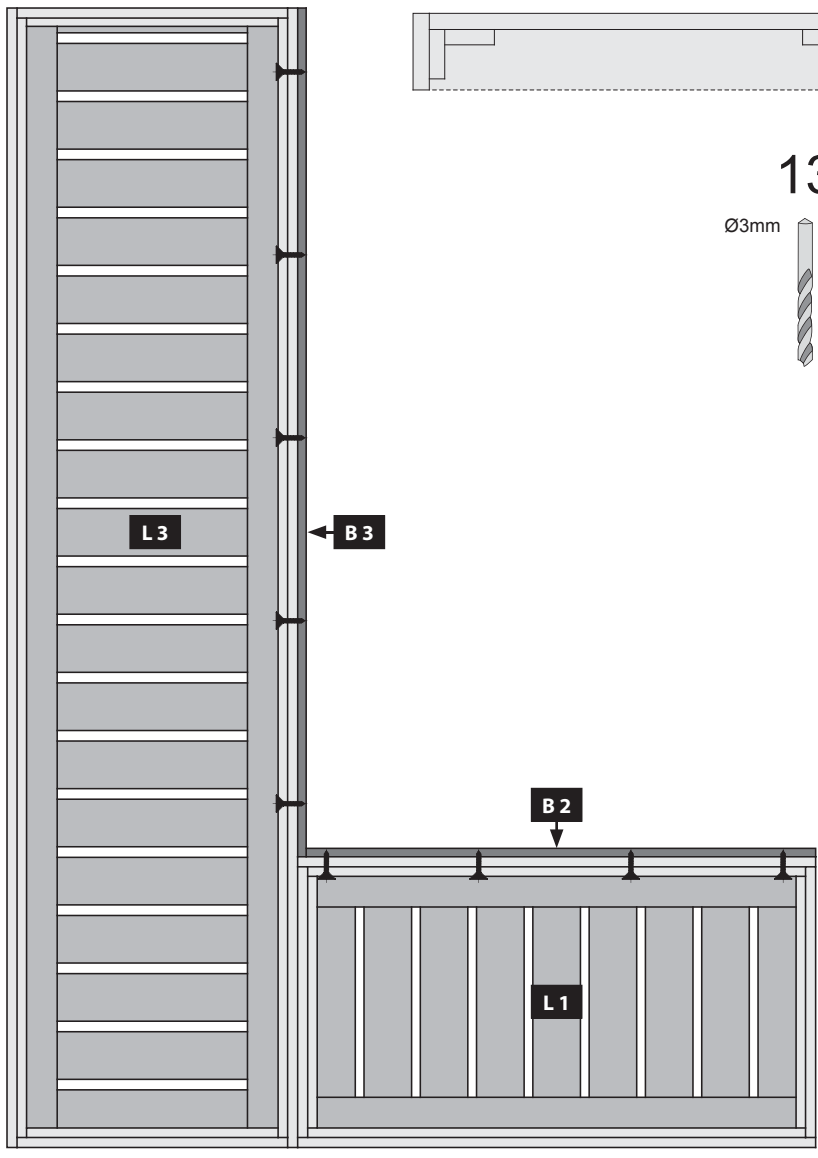
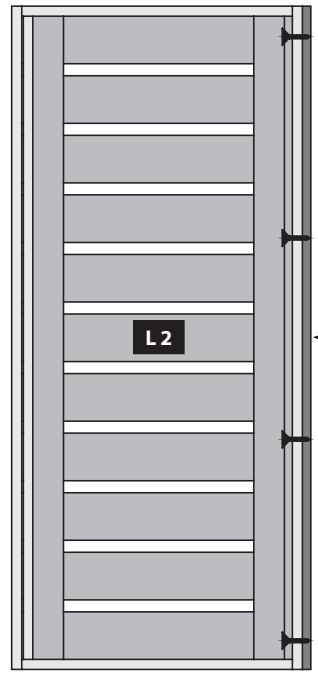

a



12x

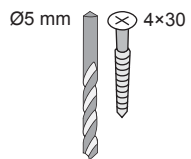

b

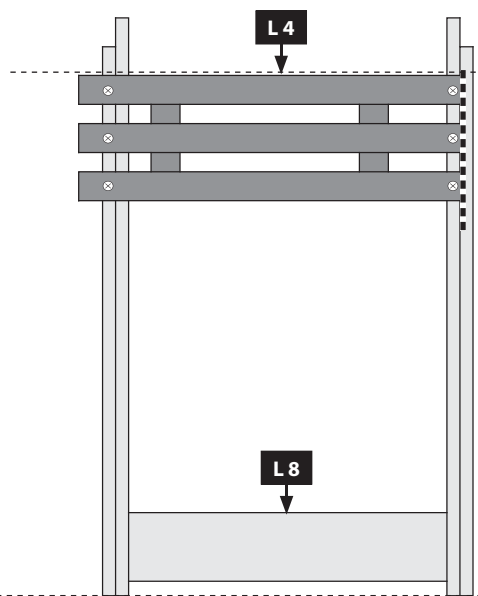

815 mm

-  Bündig!
-  Flush!
-  Affleurement!
-  Gelijk!
-  I flugt!
-  Aras!
-  Combacia!
-  Stejný!
-  Splakovanie!

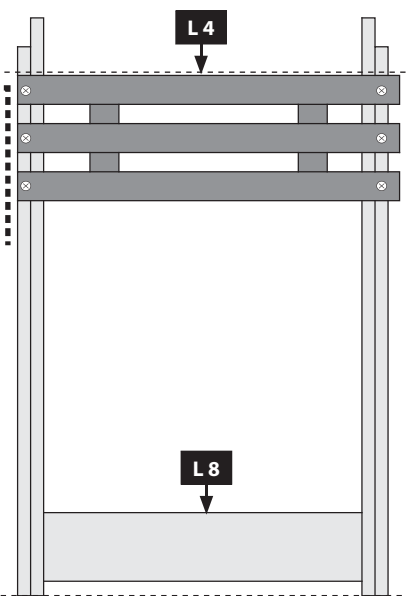

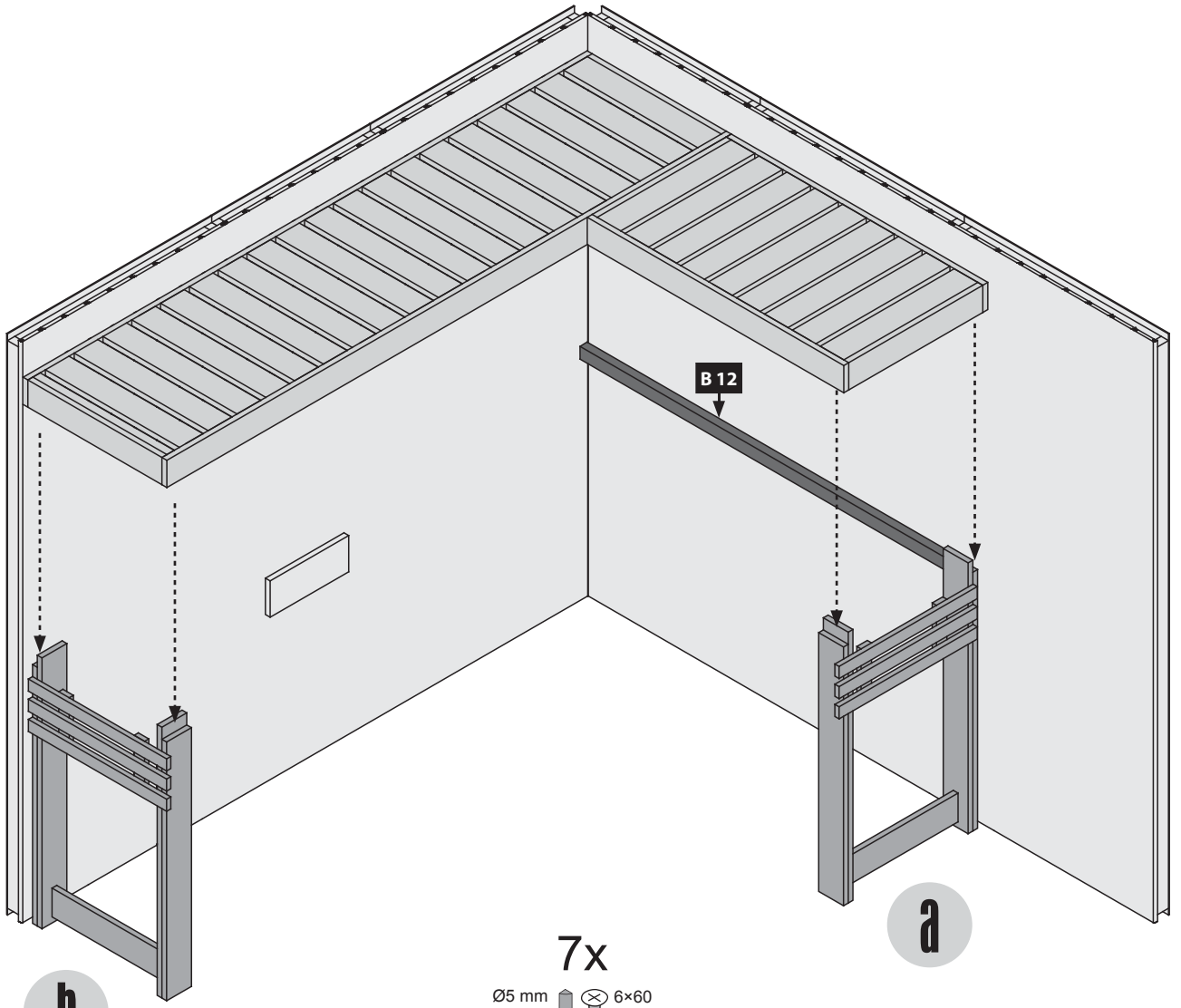

b

a

7x
Ø5 mm 6x60

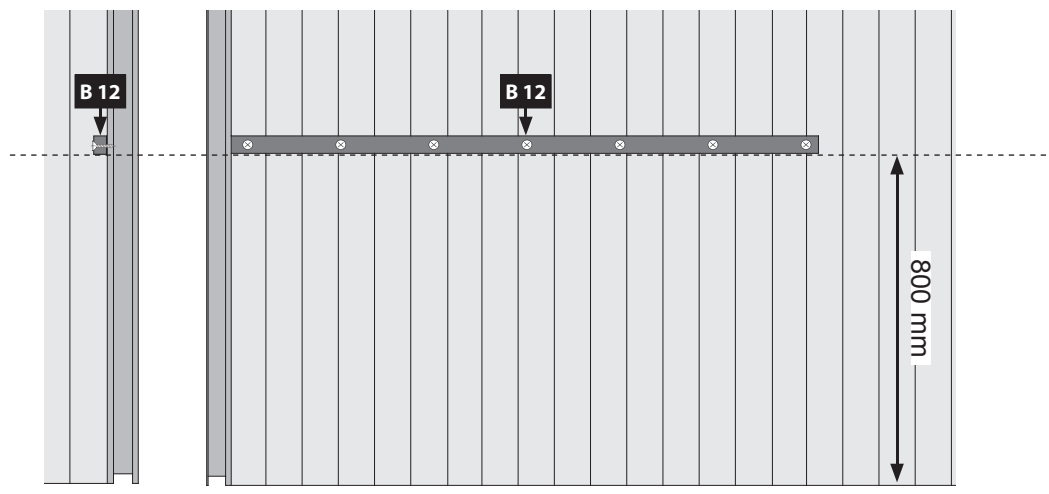

B 12

B 12

800 mm

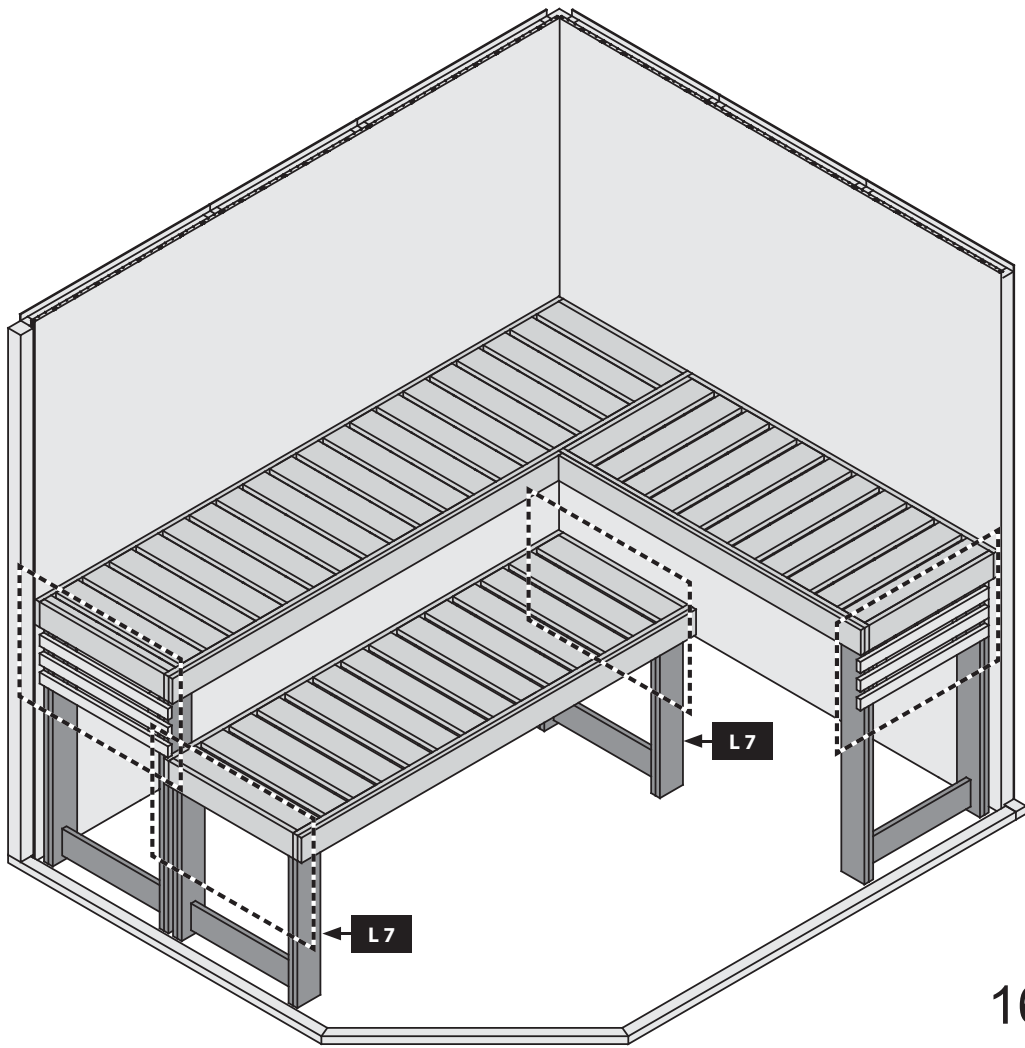

16x

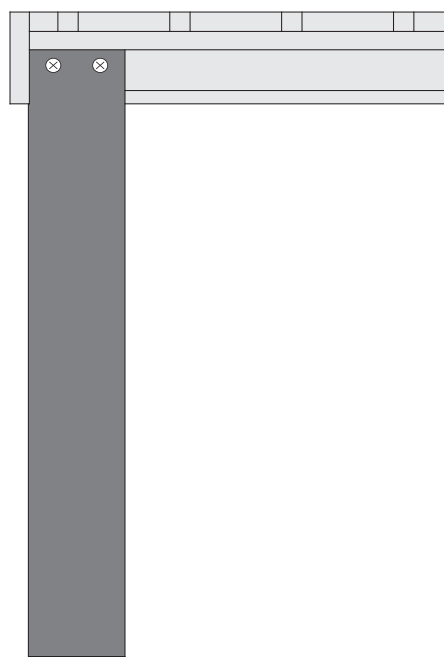
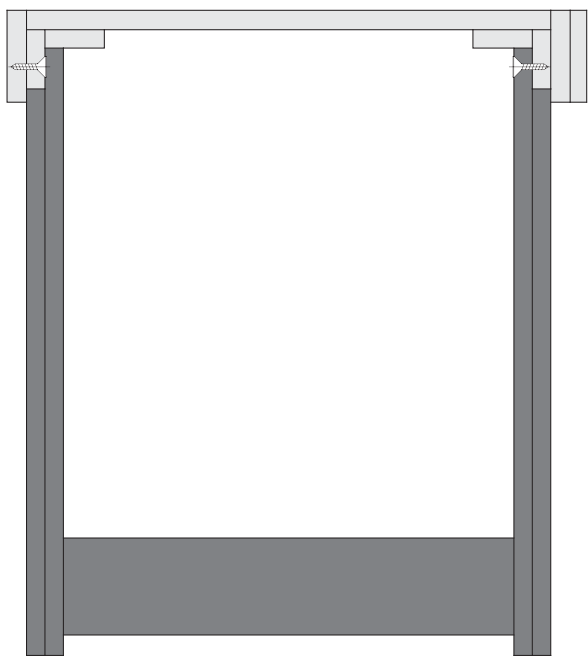
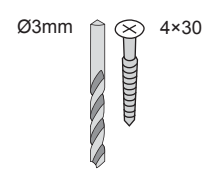

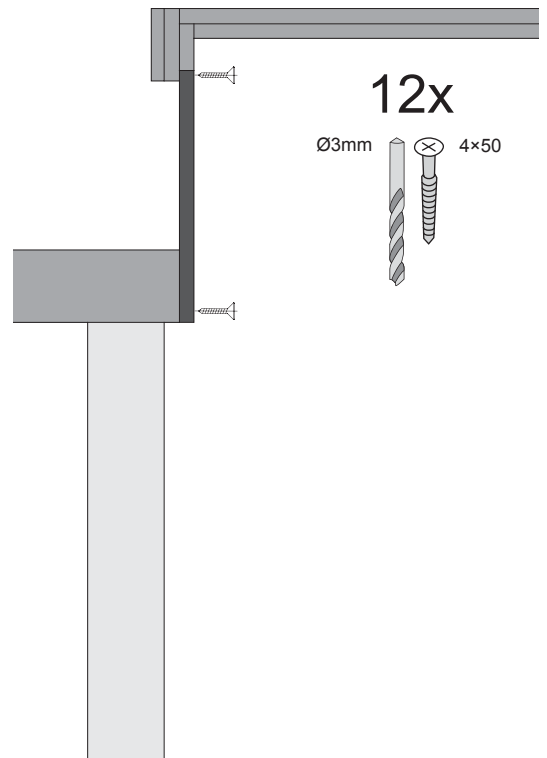
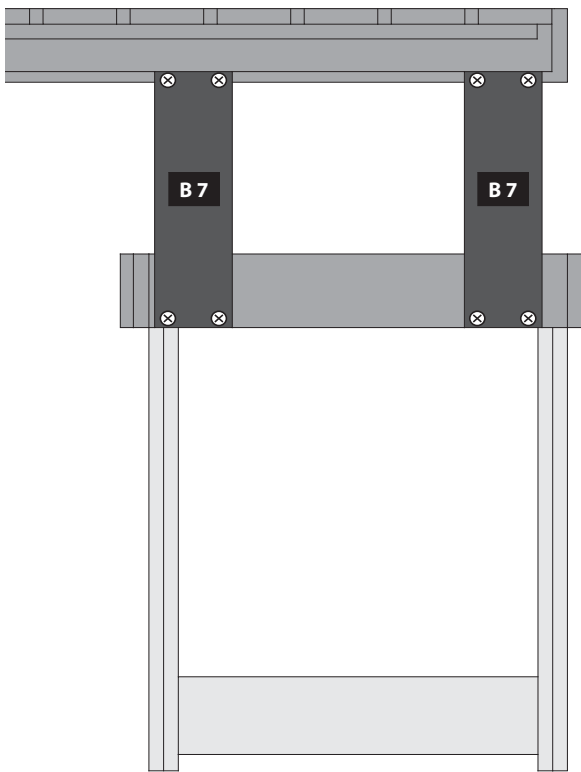
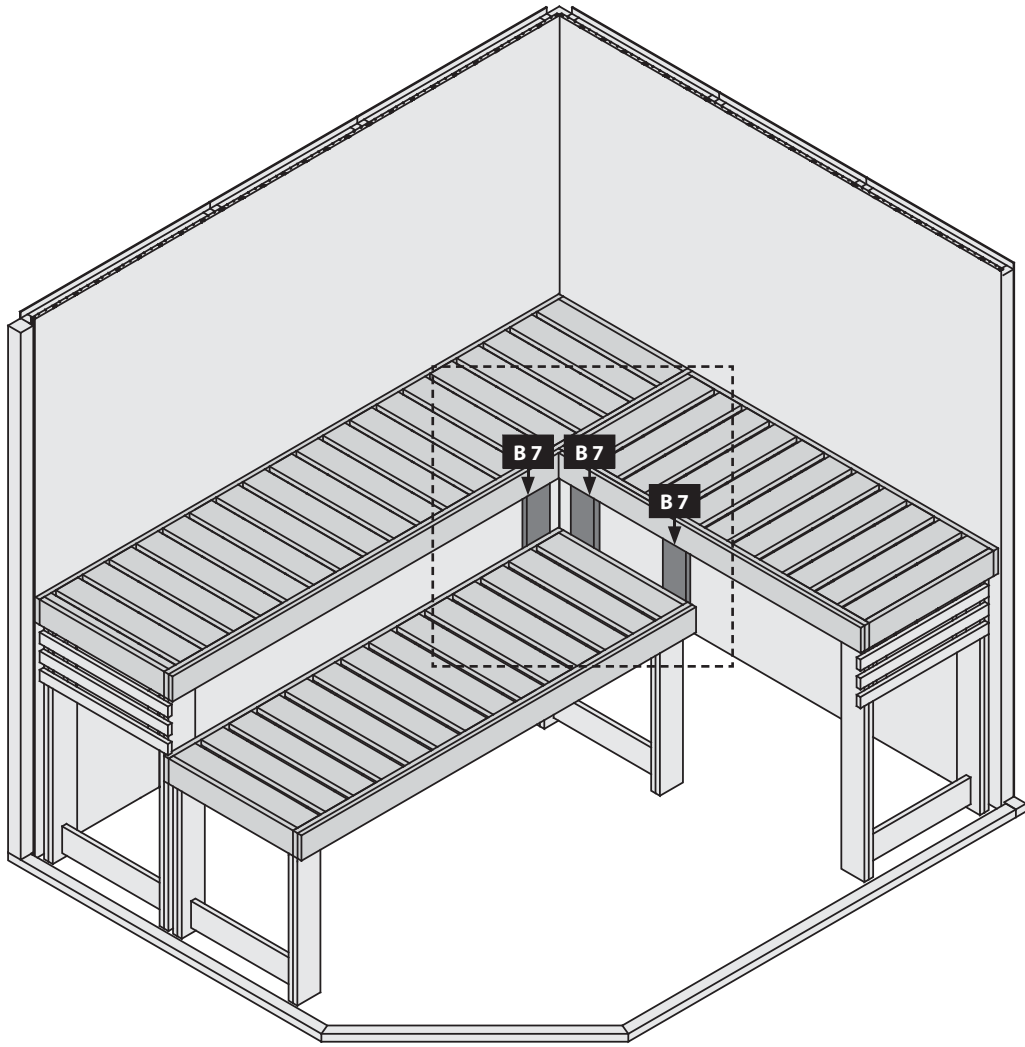

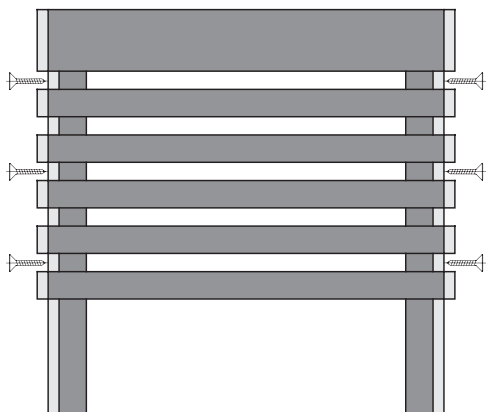
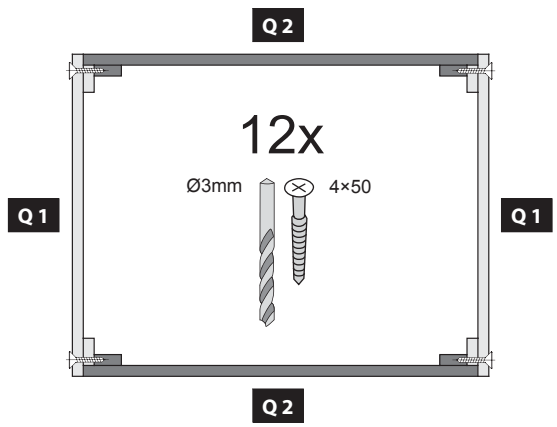
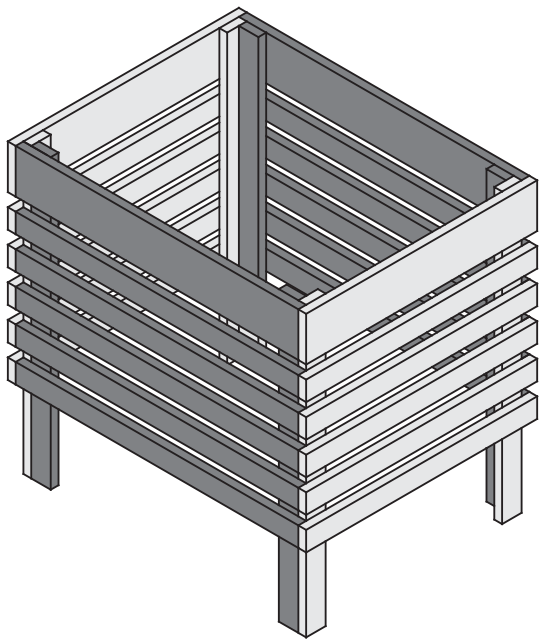
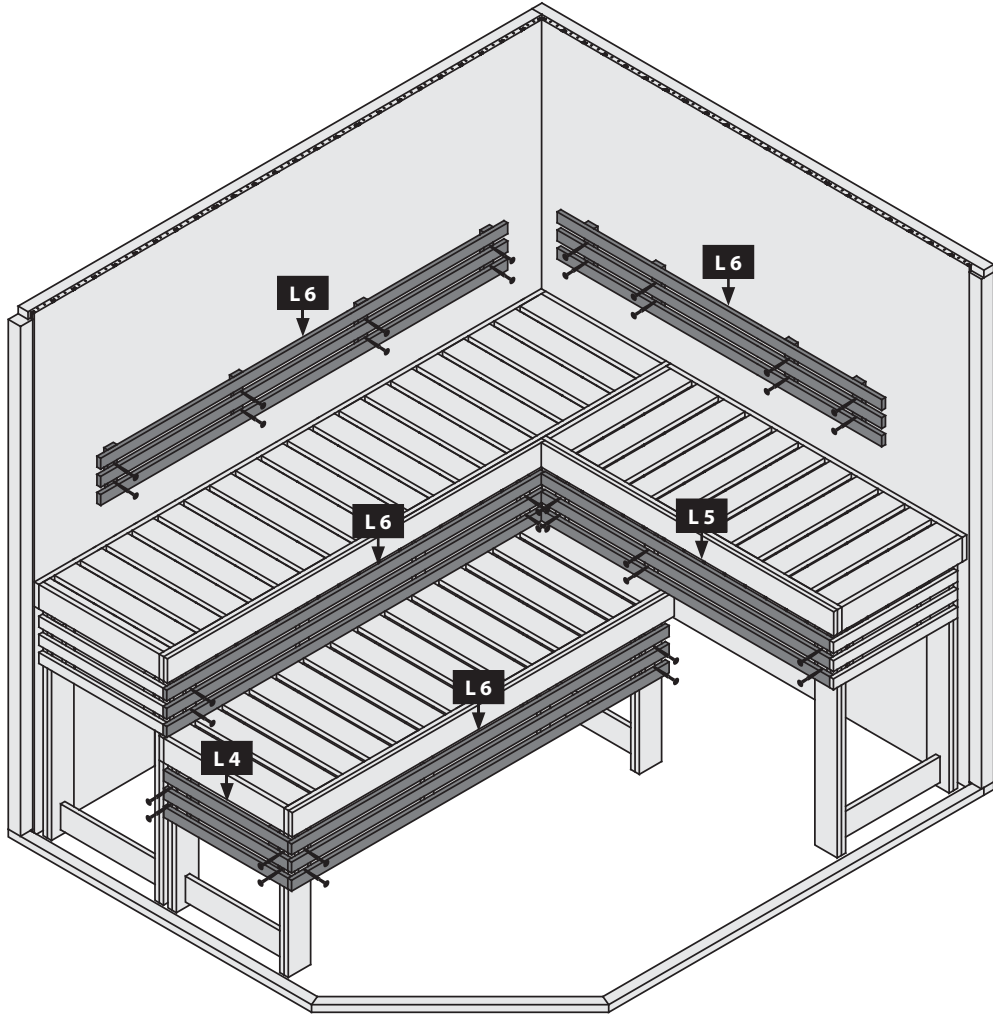

34x

Ø3mm 4x30

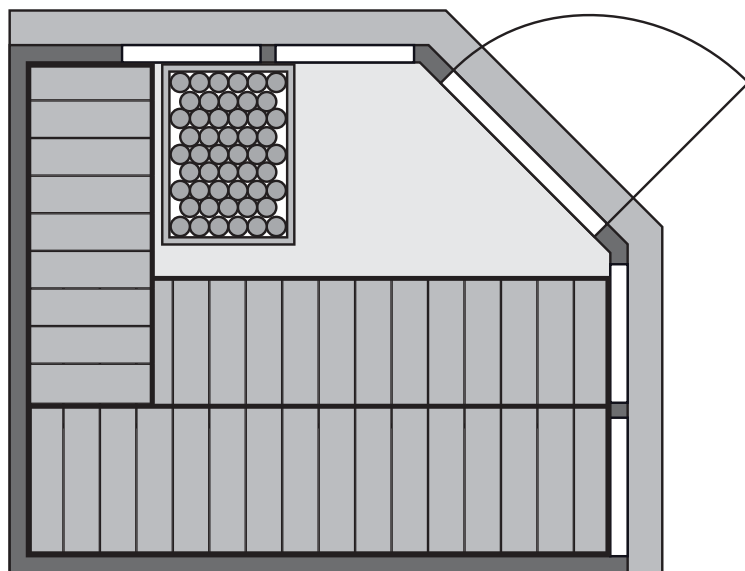
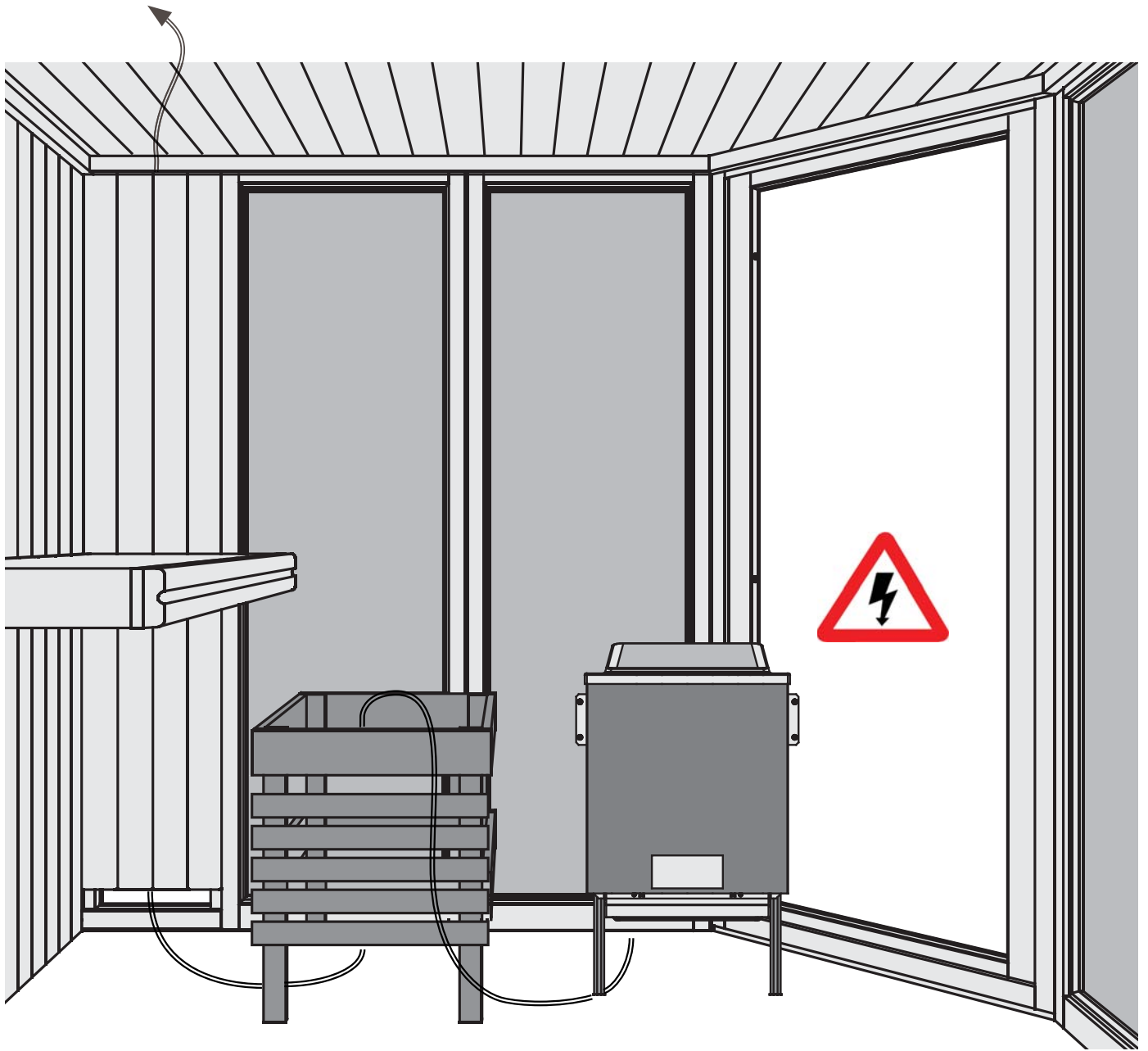





 Exemplarische Kabelverlegung

 Voorbeeld van het leggen van kabels

 Esempi di posa di cavi

 Exemplary cable laying

 Eksempel på kabellægning

 Příkladné pokládání kabelů

 Exemple de pose de câbles

 Tendido de cables ejemplar

 Vzorčno polaganje kablov

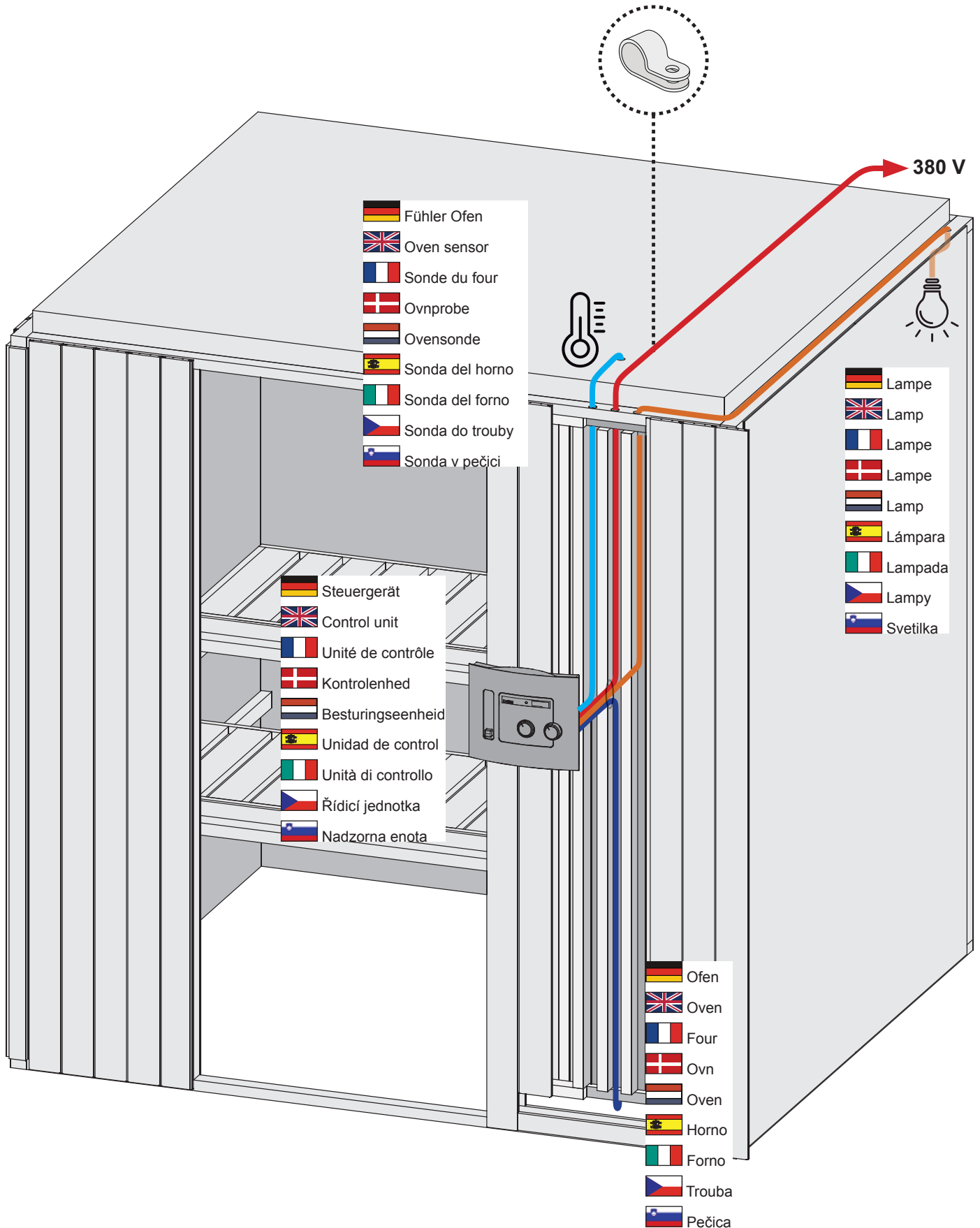
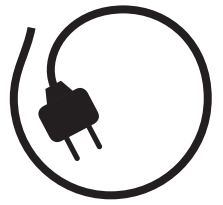



 Exemplarische Kabelverlegung

 Voorbeeld van het leggen van kabels

 Esempi di posa di cavi

 Exemplary cable laying

 Eksempel på kabellægning

 Příkladné pokládání kabelů



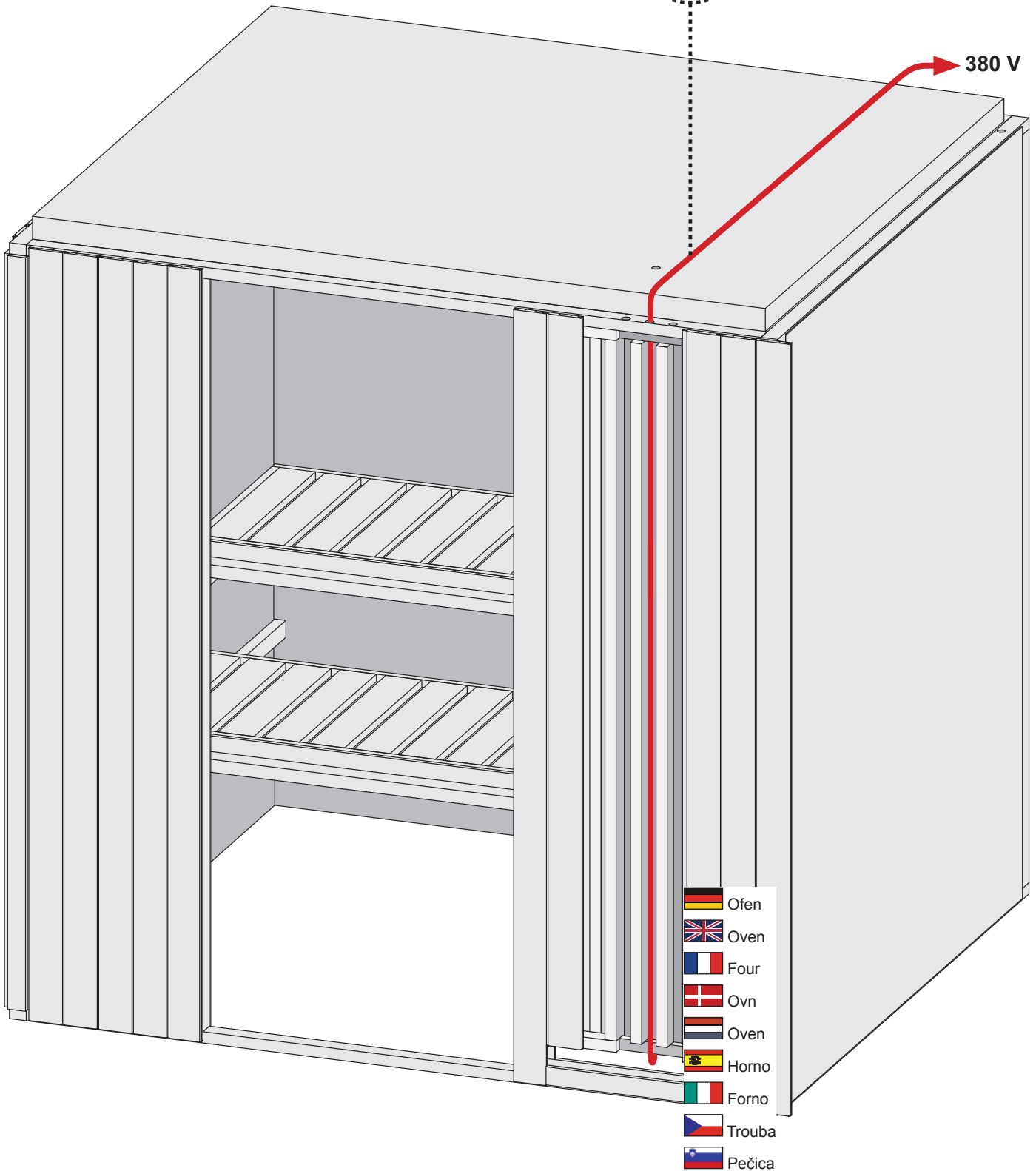
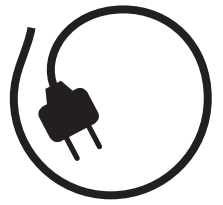

 Exemple de pose de câbles

 Tendido de cables ejemplar

 Vzorčno polaganje kablov



-  Einbau Glastür
-  Installation of glass door
-  Montage porte en verre
-  Montage van de glazen deur
-  Installationsglasdør

-  Montaje de la puerta de cristal
-  Installazione portello di vetro
-  Sauna Instalace dveře
-  Vgradnja steklenih vrat

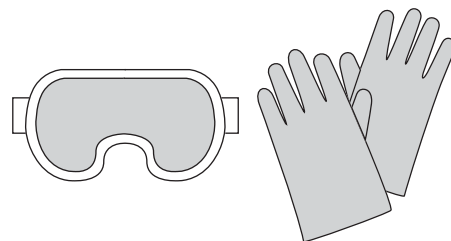



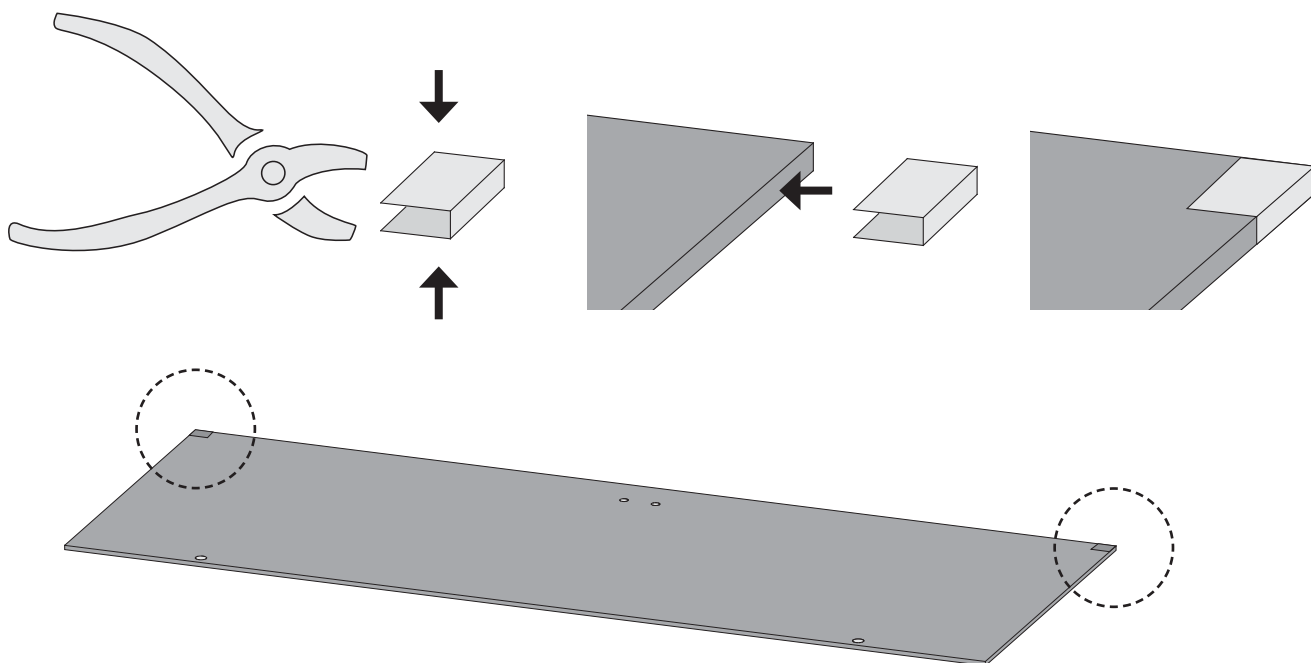



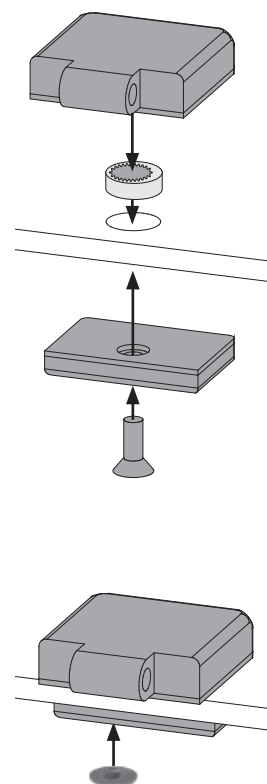
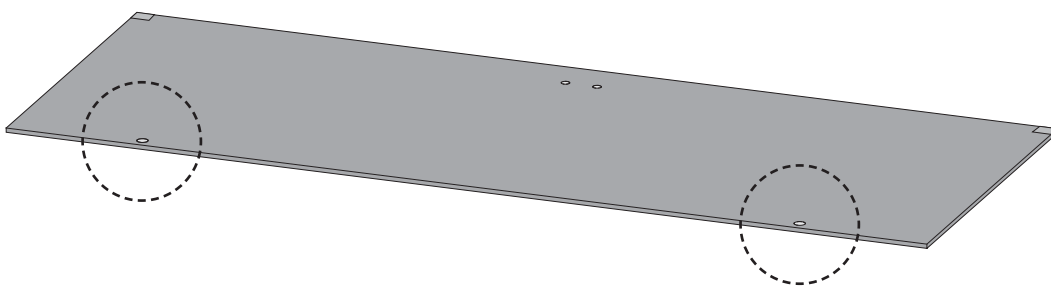

24







25





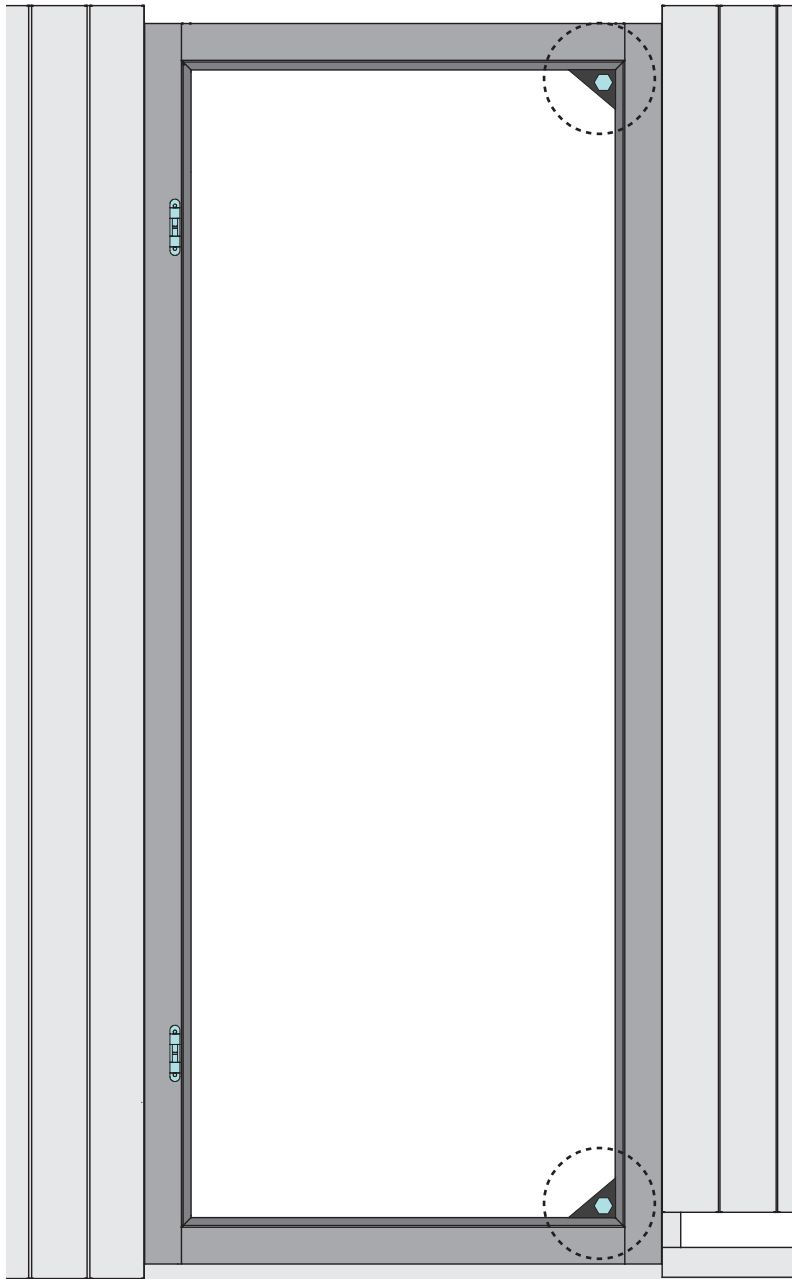
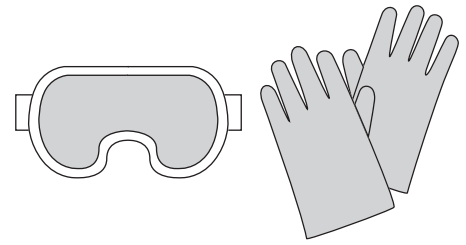

-  Alle Verstell-Excenter müssen in der Glasscheibe die gleiche Grundstellung haben
-  All adjustable eccentrics must have the same basic adjustment in the glass panel
-  Tous les excentreurs de positionnement doivent avoir la même position de base dans la vitre
-  Alle excentrische verstelelementen moeten in dezelfde stand in de glasplaat worden geplaatst
-  Alle justeringsexcenterer skal have samme grundlæggende position i glasruden
-  Todos los excéntricos regulables tienen que tener la misma posición base en la hoja de cristal
-  Tutti gli eccentrici di regolazione devono avere la stessa posizione base nella lastra di vetro
-  šechny nastavovací podivínů musí mít stejný základní polohy ve skle
-  Vsi nastavitveni ekscentri morajo imeti enak osnovni položaj v steklu.

-  Einbau Glastür
-  Installation of glass door
-  Montage porte en verre
-  Montage van de glazen deur
-  Installationsglasdør

-  Montaje de la puerta de cristal
-  Installazione portello di vetro
-  Sauna Instalace dveře
-  Vgradnja steklenih vrat







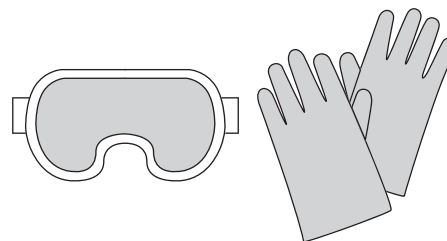



-  Einbau Glastür
-  Installation of glass door
-  Montage porte en verre
-  Montage van de glazen deur
-  Installationsglasdør

-  Montaje de la puerta de cristal
-  Installazione portello di vetro
-  Sauna Instalace dveře
-  Vgradnja steklenih vrat



27

-  Alle Verstell-Excenter müssen in der Glasscheibe die gleiche Grundstellung haben
-  All adjustable eccentrics must have the same basic adjustment in the glass panel
-  Tous les excenteurs de positionnement doivent avoir la même position de base dans la vitre
-  Alle excentrische verstelelementen moeten in dezelfde stand in de glasplaat worden geplaatst
-  Alle justeringsexcentricer skal have samme grundlæggende position i glasruden
-  Todos los excéntricos regulables tienen que tener la misma posición base en la hoja de cristal
-  Tutti gli eccentrici di regolazione devono avere la stessa posizione base nella lastra di vetro
-  všechny nastavovací podivínů musí mít stejný základní polohy ve skle
-  Vsi nastavitveni ekscentri morajo imeti enak osnovni položaj v steklu.

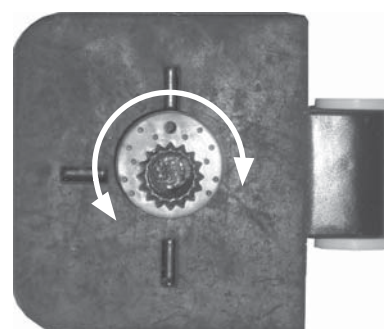
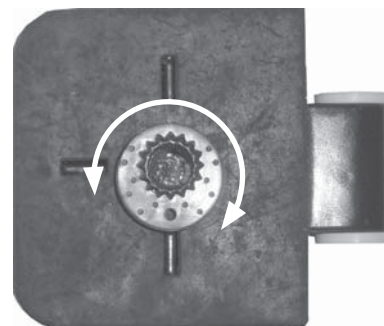
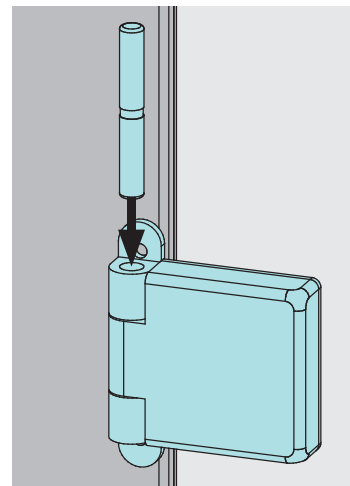
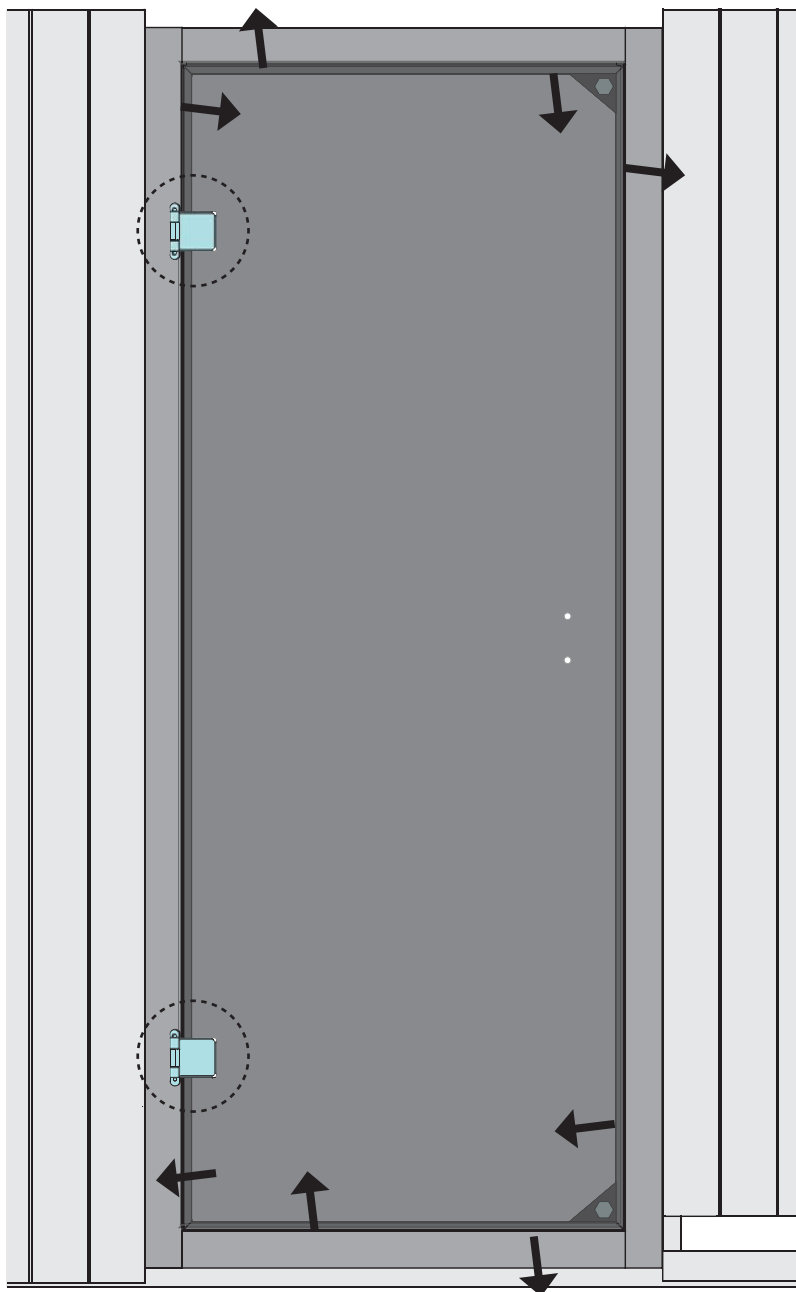

1.

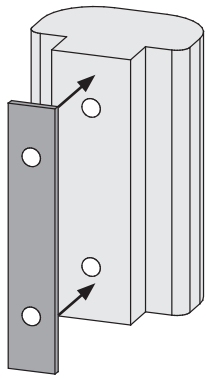

2.

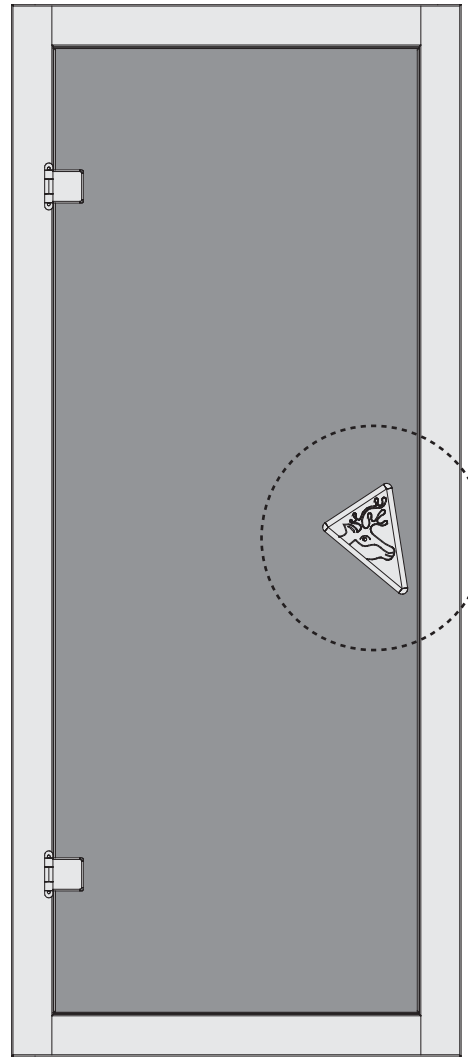
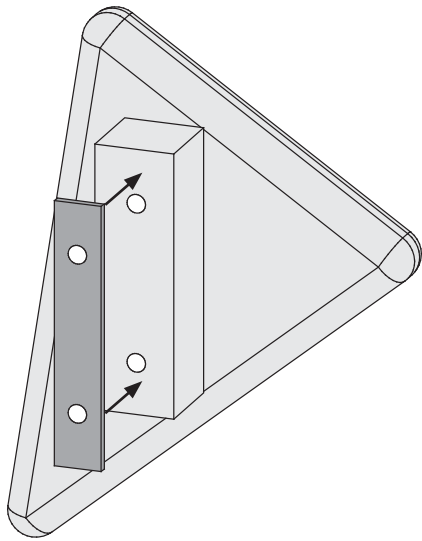

3.

